

# TABLE OF CONTENTS

## Overview

of indexes

- 4 About WITTE
- 230 Product index
- 234 Key word index
- 236 Fastener assignment
- 239 Profile finder











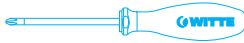
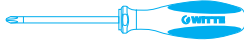





## 12 MAXX screwdrivers

Professional screwdrivers at a glance

- 14 MAXX 
- 24 MAXX Plus 
- 30 MAXX VDE 
- 36 MAXX VDE Slim 
- 40 MAXX voltage testers 
- 44 MAXXPRO Stainless 
- 48 MAXXPRO Nature 
- 52 MAXXPRO Women Line 









## 56 PRO screwdrivers

Universal screwdrivers at a glance

- 58 PRO 
- 68 PRO Plus 
- 72 PRO Impact 
- 76 PRO VDE 
- 80 PRO VDE Slim 
- 84 PRO BITDRIVE® 
- 88 PRO BITDRIVE® RATCHET 
- 92 PRO BITDRIVE® TORQUE 
- 96 PRO BITDRIVE® TORQUE VDE 
- 100 PRO ESD 
- 104 PRO voltage testers 
- 108 PRO Nature 
- 112 PRO T-bar 
- 116 PRO WITTRON® 
- 122 PRO WITTRON® VDE 
- 126 PRO WITTRON® ESD 
- 132 PRO Allen keys 









## 140 MAXX pliers & cutters

Professional pliers & cutters at a glance

- 142 MAXX heavy-duty telephone engineer's plier 
- 143 MAXX heavy-duty side-cutter 
- 144 MAXX heavy-duty combination plier 
- 146 MAXX VDE heavy-duty telephone eng. plier 
- 147 MAXX VDE multifunction side-cutter 
- 148 MAXX VDE heavy-duty side-cutter 
- 149 MAXX VDE heavy-duty combination plier 
- 150 MAXX VDE cable shear 





## 152 PRO pliers & cutters

Universal pliers & cutters at a glance

- 154 PRO radio & telephone engineer's plier 
- 155 PRO side-cutter 
- 156 PRO combination plier 
- 157 PRO water pump plier 
- 158 PRO VDE radio & telephone eng. plier 
- 159 PRO VDE combination plier 
- 160 PRO VDE wire-stripper 
- 161 PRO VDE side-cutter 

## 162 MAXX bits

Professional bits at a glance

- 164 MAXX Impact 
- 170 MAXX Stainless 
- 174 MAXX Extra hard 
- 176 MAXX TIN 
- 184 MAXX Diamond 

## 188 PRO bits

Industrial bits at a glance

- 190 PRO bits 
- 202 PRO bitholders 

## 208 BITCOMMANDER

The all-rounder

## 210 Gift boxes

## 214 Soft case sets

Just in case

## 222 POS displays and accessories

### 20 Picks & hooks

### 20 MAXX bottle-opener

### 50 MAXXPRO cork bottle-opener

### 63 PRO bottle-opener



## The KIRCHHOFF Group.

The KIRCHHOFF Group has its roots in the enterprise founded by Stephan Witte in 1785 for the manufacture of needles and pins in Iserlohn, Germany. Today's KIRCHHOFF Group, owned by the Kirchhoff family for four generations, consists of four divisions: KIRCHHOFF Automotive, KIRCHHOFF Ecotec, KIRCHHOFF Mobility and WITTE Tools. KNOWLEDGE.VALUE.CHANGE. – these are the fundamental principles that are also the motive force behind the rise and further development of the Group. They unite the more than 13,000 employees in the Group in line with our mission statement: WE.MOVE.FUTURE.



# KIRCHHOFF GROUP



### WITTE TOOLS

**WITTE Tools** continues to be rated as one of Germany's leading manufacturers of premium handtools. The WITTE brand name is a byword for high-grade screwdrivers, bits, pliers and cutters that are supplied worldwide to partners in industry & the trades and specialist distributors.

### KIRCHHOFF AUTOMOTIVE

**KIRCHHOFF Automotive** is a respected development partner of the automotive industry and focuses on complex metal and hybrid structures for bodywork and chassis. We are available worldwide as a full-service supplier.

### KIRCHHOFF ECOTEC

**KIRCHHOFF Ecotec** is the European market leader for waste collection vehicles, street sweepers, and lifters. This division was the first manufacturer to produce a fully integrated hybrid waste collection vehicle.

### KIRCHHOFF MOBILITY

**KIRCHHOFF Mobility** is one of the leading suppliers of individual vehicle conversions to enable people with disabilities to be more mobile and independent.



#### The owners of the KIRCHHOFF Group

(l. to r.):  
Dr Johannes F. Kirchhoff,  
J. Wolfgang Kirchhoff, Arndt G. Kirchhoff

### It all started with a needle

Back in 1785, WITTE started manufacturing needles for textile applications, saddlers and shoemakers. Soon, they were supplying customers worldwide. With production standing at 10 million pins and needles per year at the beginning of the 19th century, by the middle of that century, this expanding family concern was manufacturing two million per day with its staff of 1200 and was a leading producer in its field.

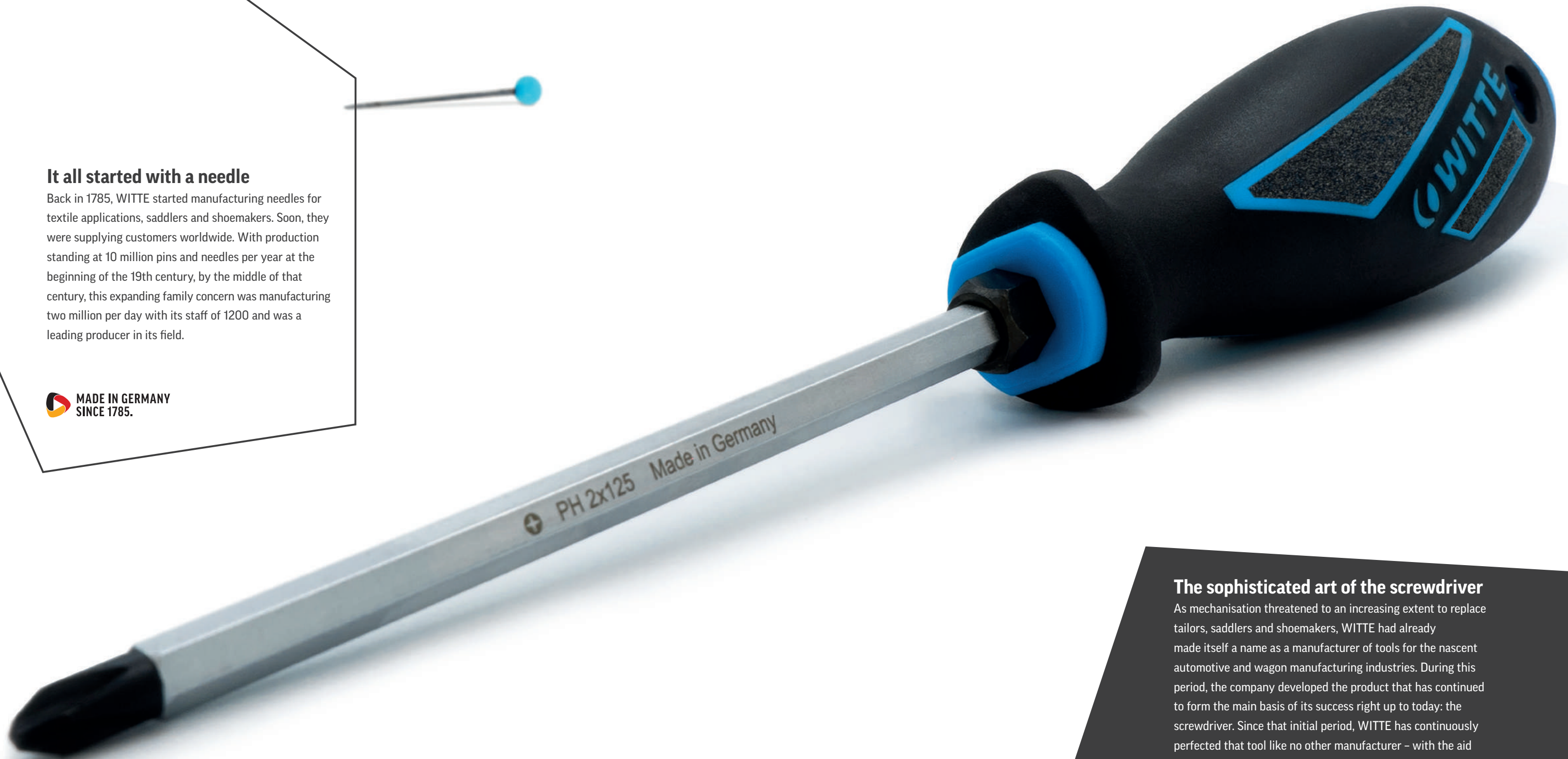

### The sophisticated art of the screwdriver

As mechanisation threatened to an increasing extent to replace tailors, saddlers and shoemakers, WITTE had already made itself a name as a manufacturer of tools for the nascent automotive and wagon manufacturing industries. During this period, the company developed the product that has continued to form the main basis of its success right up to today: the screwdriver. Since that initial period, WITTE has continuously perfected that tool like no other manufacturer - with the aid of unrelenting innovation, maximum attention to ergonomic design and materials and, of course, peak quality made in Germany.



### Quality from Germany.

German engineering skills and craftsmanship have been recognised the world over for many a year. Long before the "Made in Germany" slogan underlined the fact, WITTE was renowned for its core values such as innovation, accuracy and reliability that are central to Germany. These are virtues that we uphold to the same extent as our commitment to Germany as a manufacturing location – both these aspects are indispensable parts of our identity and quality philosophy.



Made in Germany

WUPPERTAL

SOLINGEN

COLOGNE

REMSCHIED

 WITTE  
HAGEN

### Tools with tradition.

Witte is located right at the heart of the European tool-producing region: on the edges of the Bergisch Land, which is the region that is famous for the centuries-old tradition of wire processing and tool manufacture and still today a pacesetter in the worldwide tool market. WITTE is dedicated to maintaining that heritage.

# PRO

**PRO tools** by WITTE will make any professional user's heart beat that little bit faster because those tools are, without doubt, among the best the market has to offer. The quality series for daily professional use stands out because of its ergonomically designed handles: the sculpted longitudinal contour optimises contact pressure and promotes strain-free working. The screwdriver handles are made up of three plastic components and ensure excellent grip.

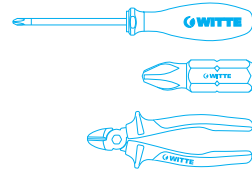

### Sophisticated

The central section of the PRO screwdriver handle – the spin zone – is shaped using a well-rounded triangular form. This enables the user to apply optimum force transmission, which reduces the amount of effort required to do the job. Fast screw tightening and unscrewing are facilitated by the extended multifunction zone.



### Robust

WITTE PRO bits offer consistently high quality standards due to our state-of-the-art production systems. The complex hardening process guarantees permanent hardness of 59–61 HRC to meet tough requirements in industry and the trades.



### High-grade

Additionally induction hardened cutters, ergonomically designed 2-component handles and high-quality materials are notable features of the WITTE PRO series of pliers and cutters.

# MAXX

Standard  
PRO  
MAXX



**MAXX tools** – the ideal tools for professionals – when the best is just good enough.

The design of the MAXX tightening tools and MAXX pliers & cutters is based on the latest research techniques in the field of occupational science, ergonomic design and material science. Shape, hand-picked materials, ergonomic design, workmanship and physics all combine here to make a perfect tool. The result is that, if only minimum force is applied, MAXX tools can transmit the highest possible force more effectively. In any situation.

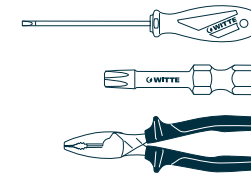

### Forceful

Ergonomics in its purest form is a feature of the MAXX range. The characteristic triangular shape of MAXX screwdriver grips provides not only the ergonomically ideal torque angle of 120°, these are also the only screwdrivers on the market in which the shape of the grip is not merely "zoomed" to produce the various sizes. Each MAXX screwdriver from WITTE boasts the ideal grip size that is specially developed as the correct ergonomic design for optimum force transmission.



### Durable

Thoroughly hardened and tempered materials enhance not only the appearance of the tool but also its functionality. At the same time, they guarantee extremely long service lifetimes and ensure user satisfaction while they work. Quality that pays for itself.



### Uncompromising

The outstanding craftsmanship used in every detail coupled with the highest grade materials dispels any doubts that, thanks to their specially constructed high-performance joints, S-shaped handles with multicomponent grips and additionally induction hardened cutters, the WITTE MAXX series of pliers and cutters are a byword for perfect ergonomic design, firm-grip materials, optimised force transmission and long service lifetimes.

On the following pages, you will be able to see which family of tools you are currently looking at due to the colour coding: dark blue stands for **MAXX**, cyan for **PRO**.



**MAXX**

# Screwdrivers



## 12 Screwdrivers

Professional screwdrivers at a glance

- |    |                      |  |
|----|----------------------|--|
| 14 | MAXX                 |  |
| 24 | MAXX Plus            |  |
| 30 | MAXX VDE             |  |
| 36 | MAXX VDE Slim        |  |
| 40 | MAXX voltage testers |  |
| 44 | MAXXPRO Stainless    |  |
| 48 | MAXXPRO Nature       |  |
| 52 | MAXXPRO Women Line   |  |



# MAXX



**Certified by the IGR as an "ergonomic product".**  
 WITTE MAXX screwdrivers have been extensively tested by the independent IGR Institute for Health and Ergonomics with regard to usability and ergonomics and have been successfully certified to DIN 33419 / EN ISO 15537.

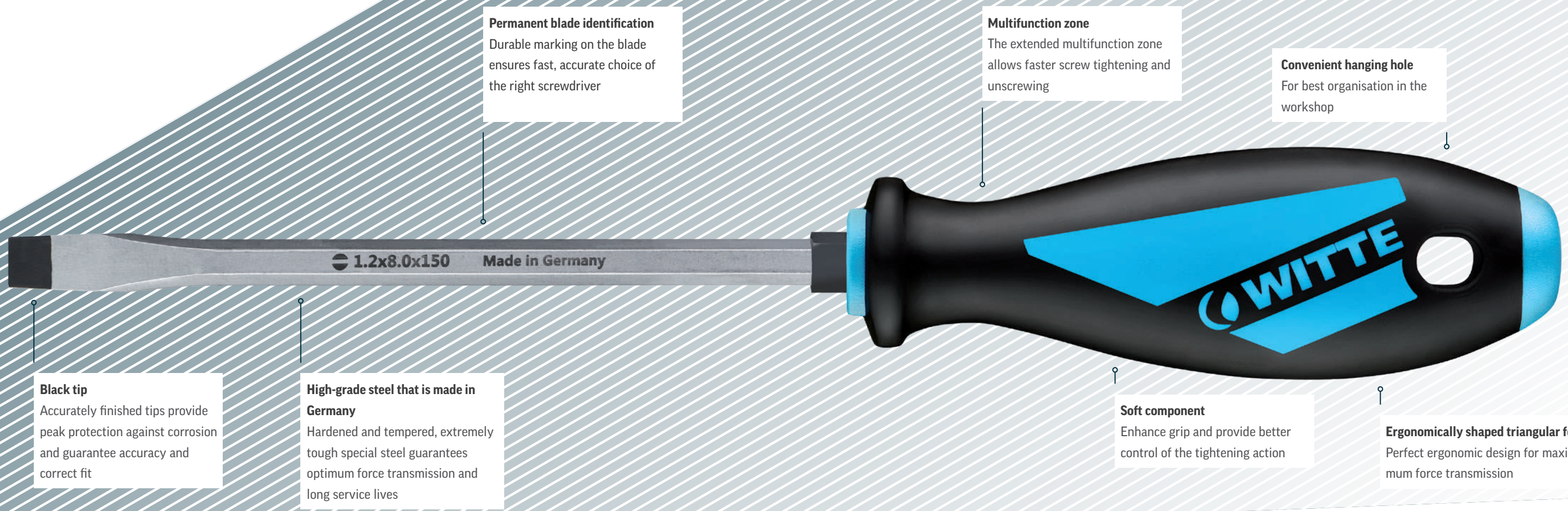

**Permanent blade identification**  
 Durable marking on the blade ensures fast, accurate choice of the right screwdriver

**Multifunction zone**  
 The extended multifunction zone allows faster screw tightening and unscrewing

**Convenient hanging hole**  
 For best organisation in the workshop

**Black tip**  
 Accurately finished tips provide peak protection against corrosion and guarantee accuracy and correct fit

**High-grade steel that is made in Germany**  
 Hardened and tempered, extremely tough special steel guarantees optimum force transmission and long service lives

**Soft component**  
 Enhance grip and provide better control of the tightening action

**Ergonomically shaped triangular form**  
 Perfect ergonomic design for maximum force transmission

Demanding craftsmen and craftswomen need tools that do not make compromises: **MAXX**. The sculpted longitudinal contour of the ergonomically designed grips allows high axial forces to be applied to the screw without excessive effort. This generates high contact pressure while effectively preventing cam-out. The soft component on the edges of the grip supports a snug fit and helps to generate maximum torque.

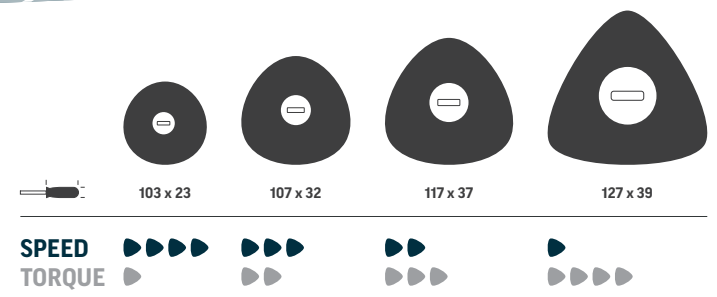

Exclusively available from WITTE: four handle sizes and shapes to match each size of screw head. Our grips are not merely "pinch zoomed" for the next size but individually shaped for the correct contour, centre of gravity and form.

The lower the required torque, the more round the grip cross-section to enable faster, accurate turns. The greater the required torque, the larger the grip, so it lies snugly in the hand and guarantees safe, accurate application of force.

### The benefits

- Tried-and-tested three-sided shape corresponds to the hand's ideal tightening angle (120°)
- The spin zone made of softer material makes working with the tool faster and more satisfying
- Matt chrome-plated, permanently marked blades made of hardened and tempered special steel in all profiles
- Black tips guarantee peak accuracy and correct fit

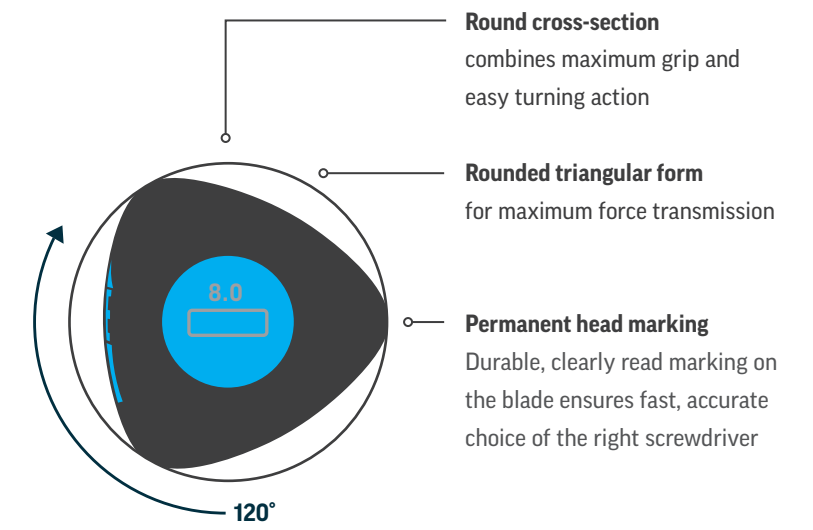



## 53100 slotted keystone/engineer's screwdrivers

to DIN 5264 and ISO 2380



ITEM NO.	mm	mm	mm	mm	ITEM NO.	mm	mm	mm	mm
53101	0.6 x 3.5	75	3.5	103 x 23	53107	1.2 x 6.5	125	6.0	117 x 37
53102	0.6 x 3.5	100	3.5	103 x 23	53108	1.2 x 6.5	150	6.0	117 x 37
53103	0.8 x 4.0	75	4.0	103 x 23	53109	1.2 x 8.0	150	7.0	127 x 39
53104	0.8 x 4.0	100	4.0	103 x 23	53110	1.6 x 8.0	175	7.0	127 x 39
53105	1.0 x 5.5	100	5.0	107 x 32	53111	1.6 x 10.0	200	8.0	127 x 39
53106	1.0 x 5.5	125	5.0	107 x 32					

## 53010 slotted keystone/engineer's screwdrivers

to DIN 5264 and ISO 2380, hexagonal blade and bolster dimensionally accurate to DIN 475



ITEM NO.	mm	mm	mm	shank	mm	ITEM NO.	mm	mm	mm	shank	mm
53010	0.8 x 4.0	100	8.0	5.0	107 x 32	53014	1.6 x 10.0	200	13.0	8.0	127 x 39
53011	1.0 x 5.5	125	8.0	5.0	107 x 32	53015	2.0 x 12.0	225	-	10.0	127 x 39
53012	1.2 x 6.5	150	10.0	6.0	117 x 37	53016	2.5 x 14.0	275	-	10.0	127 x 39
53013	1.2 x 8.0	175	13.0	8.0	127 x 39						

## 53020 slotted cabinet / electrician's screwdrivers

to DIN 5264 and ISO 2380

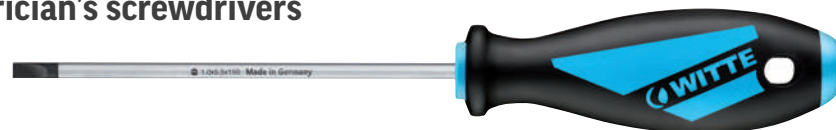

ITEM NO.	mm	mm	mm	mm
53021	0.5 x 3.0	75	3.0	103 x 23
53022	0.6 x 3.5	100	3.5	103 x 23
53023	0.6 x 4.0	300	4.0	103 x 23
53024	0.8 x 4.0	125	4.0	103 x 23
53025	1.0 x 5.5	150	5.5	107 x 32
53026	1.0 x 5.5	200	5.5	107 x 32
53027	1.0 x 5.5	300	5.5	107 x 32

## 53030 PH screwdrivers

to ISO 8764 for PHILLIPS recess screws



ITEM NO.		mm	mm	mm	ITEM NO.		mm	mm	mm
53031	PH 0	60	3.0	103 x 23	53036	PH 2	200	6.0	117 x 37
53032	PH 1	80	4.5	107 x 32	53037	PH 2	300	6.0	117 x 37
53034	PH 1	300	4.5	107 x 32	53038	PH 3	150	8.0	127 x 39
53035	PH 2	100	6.0	117 x 37	53039	PH 4	200	10.0	127 x 39
53033	PH 2	150	6.0	117 x 37					

## 53500 PH screwdrivers

to ISO 8764 for PHILLIPS recess screws, hexagonal blade and bolster dimensionally accurate to DIN 475



ITEM NO.		mm	mm	shank	mm
53501	PH 1	105	8.0	5.0	107 x 32
53502	PH 2	125	10.0	6.0	117 x 37
53503	PH 3	175	13.0	8.0	127 x 39

## 53040 PZ screwdrivers

to ISO 8764 for POZIDRIV screws



ITEM NO.		mm	mm	mm	ITEM NO.		mm	mm	mm
53041	PZ 0	60	3.0	103 x 23	53047	PZ 2	300	6.0	117 x 37
53042	PZ 1	80	4.5	107 x 32	53048	PZ 3	150	8.0	127 x 39
53044	PZ 1	300	4.5	107 x 32	53049	PZ 4	200	10.0	127 x 39
53045	PZ 2	100	6.0	117 x 37					

## 53600 PZ screwdrivers

to ISO 8764 for POZIDRIV screws, hexagonal blade and bolster dimensionally accurate to DIN 475



ITEM NO.		mm	mm	shank	mm
53601	PZ 1	105	8.0	5.0	107 x 32
53602	PZ 2	125	10.0	6.0	117 x 37
53603	PZ 3	175	13.0	8.0	127 x 39

## 53200 TORX® screwdrivers



ITEM NO.		mm	mm	mm	ITEM NO.		mm	mm	mm
53201	T 5	60	3.0	103 x 23	53208	T 20	100	4.5	107 x 32
53202	T 6	60	3.0	103 x 23	53209	T 25	100	4.5	107 x 32
53203	T 7	60	3.0	103 x 23	53210	T 27	115	6.0	117 x 37
53204	T 8	60	3.0	103 x 23	53211	T 30	115	6.0	117 x 37
53205	T 9	60	3.0	103 x 23	53212	T 40	115	7.0	127 x 39
53206	T 10	80	3.5	103 x 23	53213	T 45	130	8.0	127 x 39
53207	T 15	80	3.5	103 x 23					

## 53300 TORX® screwdrivers

with central bore, TR tamper resistant



ITEM NO.	Icon	mm	mm	mm	ITEM NO.	Icon	mm	mm	mm
53303	TR 7	60	3.0	103 x 23	53309	TR 25	100	4.5	107 x 32
53304	TR 8	60	3.0	103 x 23	53310	TR 27	115	6.0	117 x 37
53305	TR 9	60	3.0	103 x 23	53311	TR 30	115	6.0	117 x 37
53306	TR 10	80	3.5	103 x 23	53312	TR 40	115	7.0	127 x 39
53307	TR 15	80	3.5	103 x 23	53313	TR 45	130	8.0	127 x 39
53308	TR 20	100	4.5	107 x 32					

## 53050 ball-end hex screwdrivers



ITEM NO.	Icon	mm	mm
53051	3.0	100	103 x 23
53052	4.0	100	103 x 23
53053	5.0	100	107 x 32
53054	6.0	125	117 x 37
53055	8.0	150	127 x 39

## 53060 square drive screwdrivers

for Robertson screws



ITEM NO.	Icon	mm	mm	mm
53061	1.0	100	4.5	107 x 32
53062	2.0	125	5.0	107 x 32
53063	3.0	150	6.0	117 x 37

## 53070 TRI-WING screwdrivers



ITEM NO.	Icon	mm	mm
53071	TW 2	80	107 x 32
53072	TW 3	100	107 x 32
53073	TW 4	100	107 x 32
53074	TW 5	100	107 x 32

## 53400 nutdrivers



ITEM NO.	Icon	mm	mm	ITEM NO.	Icon	mm	mm	ITEM NO.	Icon	mm	mm
53401	3.5	125	107 x 32	53406	6.0	125	117 x 37	53411	11.0	125	127 x 39
53402	4.0	125	107 x 32	53407	7.0	125	117 x 37	53412	12.0	125	127 x 39
53403	4.5	125	107 x 32	53408	8.0	125	117 x 37	53413	13.0	125	127 x 39
53404	5.0	125	107 x 32	53409	9.0	125	117 x 37	53414	14.0	125	127 x 39
53405	5.5	125	107 x 32	53410	10.0	125	117 x 37	53415	17.0	125	127 x 39

## 53080 nutdrivers

with flexible shank



ITEM NO.	Icon	mm	mm	ITEM NO.	Icon	mm	mm
53081	5.0	210	117 x 37	53084	7.0	210	117 x 37
53082	5.5	210	117 x 37	53085	8.0	210	117 x 37
53083	6.0	210	117 x 37	53086	1/4"	210	117 x 37

## 53091 bitholder

with 150 mm blade and permanent magnet

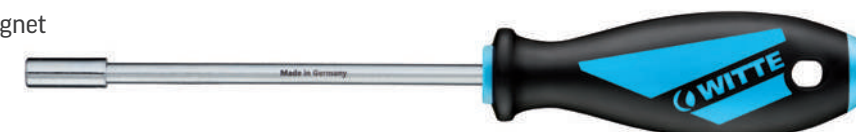

ITEM NO.	Icon	mm	mm
53091	1/4"	150	117 x 37

## 86990 slotted stubby screwdriver



ITEM NO.	Icon	mm	mm	mm	ITEM NO.	Icon	mm	mm	mm
86991	0.8 x 4.5	25	4.5	55 x 29	86993	1.2 x 8.0	25	8.0	55 x 29
86992	1.0 x 6.0	25	6.0	55 x 29					

## 94260 PH stubby screwdriver

to ISO 8764 for PHILLIPS recess screws





ITEM NO.	Icon	mm	mm	mm
94261	PH 1	25	4.5	55 x 29
94262	PH 2	25	6.0	55 x 29





**95350 PZ stubby screwdriver**  
to ISO 8764 for POZIDRIV screws



ITEM NO.	 mm	 mm	 mm
95351	PZ 1	25	4.5
95352	PZ 2	25	6.0



**967 bottle-opener**



ITEM NO.	 mm	 mm
967	43	117 x 37



**53622 awl**





ITEM NO.	 mm	 mm	 mm
53622	100	6.0	117 x 37

**53832 square reamer**



ITEM NO.	 mm	 mm	 mm
53832	100	6.0	117 x 37

**691008 set of picks & hooks in a wallet, 4-pcs. set**

ITEM NO.	 mm	 mm	 mm
691008	70	3.5	103 x 23





Sets of screwdrivers



— Market-orientated tool sets  
Exactly what customers want. Compiled through many years' observation of practical applications.

**6-pcs. set**  
Order no. 653754

ITEM NO.	Drive	mm	mm
53105	●	1.0 x 5.5	100
53107	●	1.2 x 6.5	125
53032	⊕	PH 1	80
53035	⊕	PH 2	100
53042	⊕	PZ 1	80
53045	⊕	PZ 2	100

**6-pcs. set**  
Order no. 653832

ITEM NO.	Drive	mm	mm
53021	●	0.5 x 3.0	75
53104	●	0.8 x 4.0	100
53106	●	1.0 x 5.5	125
53108	●	1.2 x 6.5	150
53032	⊕	PH 1	80
53035	⊕	PH 2	100

**6-pcs. set**  
Order no. 653833

ITEM NO.	Drive	mm	mm
53021	●	0.5 x 3.0	75
53104	●	0.8 x 4.0	100
53106	●	1.0 x 5.5	125
53108	●	1.2 x 6.5	150
53042	⊕	PZ 1	80
53045	⊕	PZ 2	100

**6-pcs. set**  
Order no. 653864

ITEM NO.	Drive	mm	mm
53103	●	0.8 x 4.0	75
53105	●	1.0 x 5.5	100
53107	●	1.2 x 6.5	125
53109	●	1.2 x 8.0	150
53032	⊕	PH 1	80
53035	⊕	PH 2	100

**6-pcs. set**  
Order no. 653863

ITEM NO.	Drive	mm	mm
53103	●	0.8 x 4.0	75
53105	●	1.0 x 5.5	100
53107	●	1.2 x 6.5	125
53109	●	1.2 x 8.0	150
53042	⊕	PZ 1	80
53045	⊕	PZ 2	100

**6-pcs. set**  
Order no. 653867

ITEM NO.	Drive	mm	mm
53010	●	0.8 x 4.0	100
53011	●	1.0 x 5.5	125
53012	●	1.2 x 6.5	150
53013	●	1.2 x 8.0	175
53501	⊕	PH 1	105
53502	⊕	PH 2	125

**6-pcs. set**  
Order no. 653868

ITEM NO.	Drive	mm	mm
53010	●	0.8 x 4.0	100
53011	●	1.0 x 5.5	125
53012	●	1.2 x 6.5	150
53013	●	1.2 x 8.0	175
53601	⊕	PZ 1	105
53602	⊕	PZ 2	125

**6-pcs. set**  
Order no. 653980

ITEM NO.	Drive	mm	mm
53206	⊕	T 10	80
53207	⊕	T 15	80
53208	⊕	T 20	100
53209	⊕	T 25	100
53211	⊕	T 30	115
53212	⊕	T 40	115

**6-pcs. set**  
Order no. 653726

ITEM NO.	Drive	mm	mm
53306	⊕	TR 10	80
53307	⊕	TR 15	80
53308	⊕	TR 20	100
53309	⊕	TR 25	100
53311	⊕	TR 30	115
53312	⊕	TR 40	115

**5-pcs. set**  
Order no. 653865

ITEM NO.	Drive	mm	mm
53103	●	0.8 x 4.0	75
53105	●	1.0 x 5.5	100
53107	●	1.2 x 6.5	125
53032	⊕	PH 1	80
53035	⊕	PH 2	100

**5-pcs. set**  
Order no. 653866

ITEM NO.	Drive	mm	mm
53103	●	0.8 x 4.0	75
53105	●	1.0 x 5.5	100
53107	●	1.2 x 6.5	125
53042	⊕	PZ 1	80
53045	⊕	PZ 2	100



MAXX

Plus



**Certified as ergonomic.**  
Tested by the independent  
IGR Institute for Health and  
Ergonomics

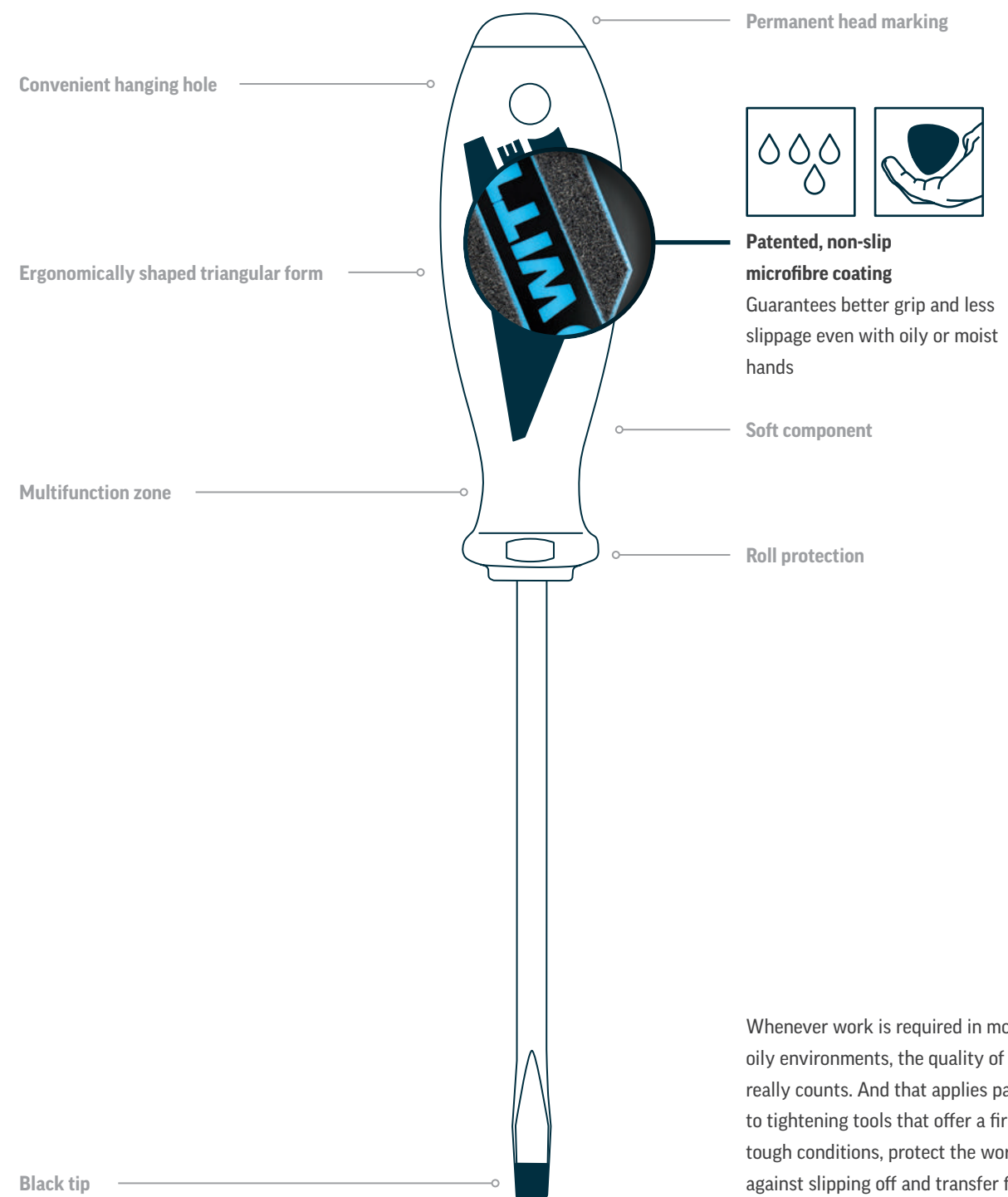

Whenever work is required in moist or oily environments, the quality of the tools really counts. And that applies particularly to tightening tools that offer a firm grip in tough conditions, protect the worker's hands against slipping off and transfer force in the most efficient way.

MAXX Plus screwdrivers are designed to excel in these conditions - from the microfibre coating and firm-grip soft handle components to effective protection against rolling.

## 63100 slotted keystone/engineer's screwdrivers

to DIN 5264 and ISO 2380



ITEM NO.	mm	mm	mm	mm	ITEM NO.	mm	mm	mm	mm
63101	0.6 x 3.5	75	3.5	103 x 23	63107	1.2 x 6.5	125	6.0	117 x 37
63102	0.6 x 3.5	100	3.5	103 x 23	63108	1.2 x 6.5	150	6.0	117 x 37
63103	0.8 x 4.0	75	4.0	103 x 23	63109	1.2 x 8.0	150	7.0	127 x 39
63104	0.8 x 4.0	100	4.0	103 x 23	63110	1.6 x 8.0	175	7.0	127 x 39
63105	1.0 x 5.5	100	5.0	107 x 32	63111	1.6 x 10.0	200	8.0	127 x 39
63106	1.0 x 5.5	125	5.0	107 x 32	63115	2.0 x 12.0	225	10.0	127 x 39

## 63010 slotted keystone/engineer's screwdrivers

to DIN 5264 and ISO 2380, hexagonal blade and bolster dimensionally accurate to DIN 475



ITEM NO.	mm	mm	mm	Klinge	mm
63011	1.0 x 5.5	125	8.0	5.0	107 x 32
63012	1.2 x 6.5	150	10.0	6.0	117 x 37
63013	1.2 x 8.0	175	13.0	8.0	127 x 39
63014	1.6 x 10.0	200	13.0	8.0	127 x 39
63015	2.0 x 12.0	225	10.0	10.0	127 x 39

## 63020 slotted cabinet / electrician's screwdrivers

to DIN 5264 and ISO 2380



ITEM NO.	mm	mm	mm	mm	ITEM NO.	mm	mm	mm	mm
63021	0.5 x 3.0	75	3.0	103 x 23	63025	1.0 x 5.5	150	5.5	107 x 32
63022	0.6 x 3.5	100	3.5	103 x 23	63026	1.0 x 5.5	200	5.5	107 x 32
63023	0.6 x 4.0	300	4.0	103 x 23	63027	1.0 x 5.5	300	5.5	107 x 32
63024	0.8 x 4.0	125	4.0	103 x 23					

## 63030 PH screwdrivers

to ISO 8764 for PHILLIPS recess screws



ITEM NO.		mm	mm	mm	ITEM NO.		mm	mm	mm
63031	PH 0	60	3.0	103 x 23	63037	PH 2	300	6.0	117 x 37
63032	PH 1	80	4.5	107 x 32	63038	PH 3	150	8.0	127 x 39
63034	PH 1	300	4.5	107 x 32	63039	PH 4	200	10.0	127 x 39
63035	PH 2	100	6.0	117 x 37					

## 63500 PH screwdrivers

to ISO 8764 for PHILLIPS recess screws, hexagonal blade and bolster dimensionally accurate to DIN 475



ITEM NO.		mm	mm	shank	mm
63501	PH 1	105	8.0	5.0	107 x 32
63502	PH 2	125	10.0	6.0	117 x 37
63503	PH 3	175	13.0	8.0	127 x 39

## 63040 PZ screwdrivers

to ISO 8764 for POZIDRIV screws



ITEM NO.		mm	mm	mm	ITEM NO.		mm	mm	mm
63041	PZ 0	60	3.0	103 x 23	63047	PZ 2	300	6.0	117 x 37
63042	PZ 1	80	4.5	107 x 32	63048	PZ 3	150	8.0	127 x 39
63044	PZ 1	300	4.5	107 x 32	63049	PZ 4	200	10.0	127 x 39
63045	PZ 2	100	6.0	117 x 37					

## 63600 PZ screwdrivers

to ISO 8764 for POZIDRIV screws, hexagonal blade and bolster dimensionally accurate to DIN 475



ITEM NO.		mm	mm	shank	mm
63601	PZ 1	105	8.0	5.0	107 x 32
63602	PZ 2	125	10.0	6.0	117 x 37
63603	PZ 3	175	13.0	8.0	127 x 39

## 63200 TORX® screwdrivers



ITEM NO.		mm	mm	mm	ITEM NO.		mm	mm	mm
63201	T 5	60	3.0	103 x 23	63208	T 20	100	4.5	107 x 32
63202	T 6	60	3.0	103 x 23	63209	T 25	100	4.5	107 x 32
63203	T 7	60	3.0	103 x 23	63210	T 27	115	6.0	117 x 37
63204	T 8	60	3.0	103 x 23	63211	T 30	115	6.0	117 x 37
63205	T 9	60	3.0	103 x 23	63212	T 40	115	7.0	127 x 39
63206	T 10	80	3.5	103 x 23	63213	T 45	130	8.0	127 x 39
63207	T 15	80	3.5	103 x 23					

## 63300 TORX® screwdrivers

with central bore, tamper resistant



ITEM NO.	Drive	mm	mm	mm	ITEM NO.	Drive	mm	mm	mm
63303	TR 7	60	3.0	103 x 23	63309	TR 25	100	4.5	107 x 32
63304	TR 8	60	3.0	103 x 23	63310	TR 27	115	6.0	117 x 37
63305	TR 9	60	3.0	103 x 23	63311	TR 30	115	6.0	117 x 37
63306	TR 10	80	3.5	103 x 23	63312	TR 40	115	7.0	127 x 39
63307	TR 15	80	3.5	103 x 23	63313	TR 45	130	8.0	127 x 39
63308	TR 20	100	4.5	107 x 32					

## 63050 ball-end hex screwdrivers



ITEM NO.	Drive	mm	mm	mm	ITEM NO.	Drive	mm	mm	mm
63051	3.0	100	103 x 23	63054	6	125	117 x 37		
63052	4.0	100	103 x 23	63055	8	150	127 x 39		
63053	5.0	100	107 x 32						

## 63060 Square drive screwdrivers

for Robertson screws



ITEM NO.	Drive	mm	mm	mm
63061	1.0	100	4.5	107 x 32
63062	2.0	125	5.0	107 x 32
63063	3.0	150	6.0	117 x 37

## 63400 nutdrivers



ITEM NO.	Drive	mm	mm	mm	ITEM NO.	Drive	mm	mm	mm
63401	3.5	125	107 x 32	63409	9.0	125	117 x 37		
63402	4.0	125	107 x 32	63410	10.0	125	117 x 37		
63403	4.5	125	107 x 32	63411	11.0	125	127 x 39		
63404	5.0	125	107 x 32	63412	12.0	125	127 x 39		
63405	5.5	125	107 x 32	63413	13.0	125	127 x 39		
63406	6.0	125	117 x 37	63414	14.0	125	127 x 39		
63407	7.0	125	117 x 37	63415	17.0	125	127 x 39		
63408	8.0	125	117 x 37	63091	1/4"	150	117 x 37		

## 63080 nutdrivers

with flexible shank



ITEM NO.	Drive	mm	mm	mm	ITEM NO.	Drive	mm	mm	mm
63081	5.0	210	117 x 37	63084	7.0	210	117 x 37		
63082	5.5	210	117 x 37	63085	8.0	210	117 x 37		
63083	6.0	210	117 x 37	63086	1/4"	210	117 x 37		

## Sets of screwdrivers

### 6-pcs. set

Order no. 663864

ITEM NO.	Drive	mm	mm
63103	0.8 x 4.0	75	
63105	1.0 x 5.5	100	
63107	1.2 x 6.5	125	
63109	1.2 x 8.0	150	
63032	PH 1	80	
63035	PH 2	100	

### 6-pcs. set

Order no. 663863

ITEM NO.	Drive	mm	mm
63103	0.8 x 4.0	75	
63105	1.0 x 5.5	100	
63107	1.2 x 6.5	125	
63109	1.2 x 8.0	150	
63042	PZ 1	80	
63045	PZ 2	100	

### 6-pcs. set

Order no. 663870

ITEM NO.	Drive	mm	mm	mm
63011	1.0 x 5.5	8	125	
63012	1.2 x 6.5	10	150	
63013	1.2 x 8.0	13	175	
63501	PH 1	6	105	
63502	PH 2	10	125	
63503	PH 3	13	175	

### 6-pcs. set

Order no. 663980

ITEM NO.	Drive	mm	mm
63206	T 10	80	
63207	T 15	80	
63208	T 20	100	
63209	T 25	100	
63211	T 30	115	
63212	T 40	115	

### 6-pcs. set

Order no. 663723

ITEM NO.	Drive	mm	mm
63306	TR 10	80	
63307	TR 15	80	
63308	TR 20	100	
63309	TR 25	100	
63311	TR 30	115	
63312	TR 40	115	

### 5-pcs. set

Order no. 663865

ITEM NO.	Drive	mm	mm
63103	0.8 x 4.0	75	
63105	1.0 x 5.5	100	
63107	1.2 x 6.5	125	
63032	PH 1	80	
63035	PH 2	100	

### 5-pcs. set

Order no. 663866

ITEM NO.	Drive	mm	mm
63103	0.8 x 4.0	75	
63105	1.0 x 5.5	100	
63107	1.2 x 6.5	125	
63042	PZ 1	80	
63045	PZ 2	100	





MAXX

VDE



**Certified as ergonomic.**  
Tested by the independent  
IGR Institute for Health and  
Ergonomics

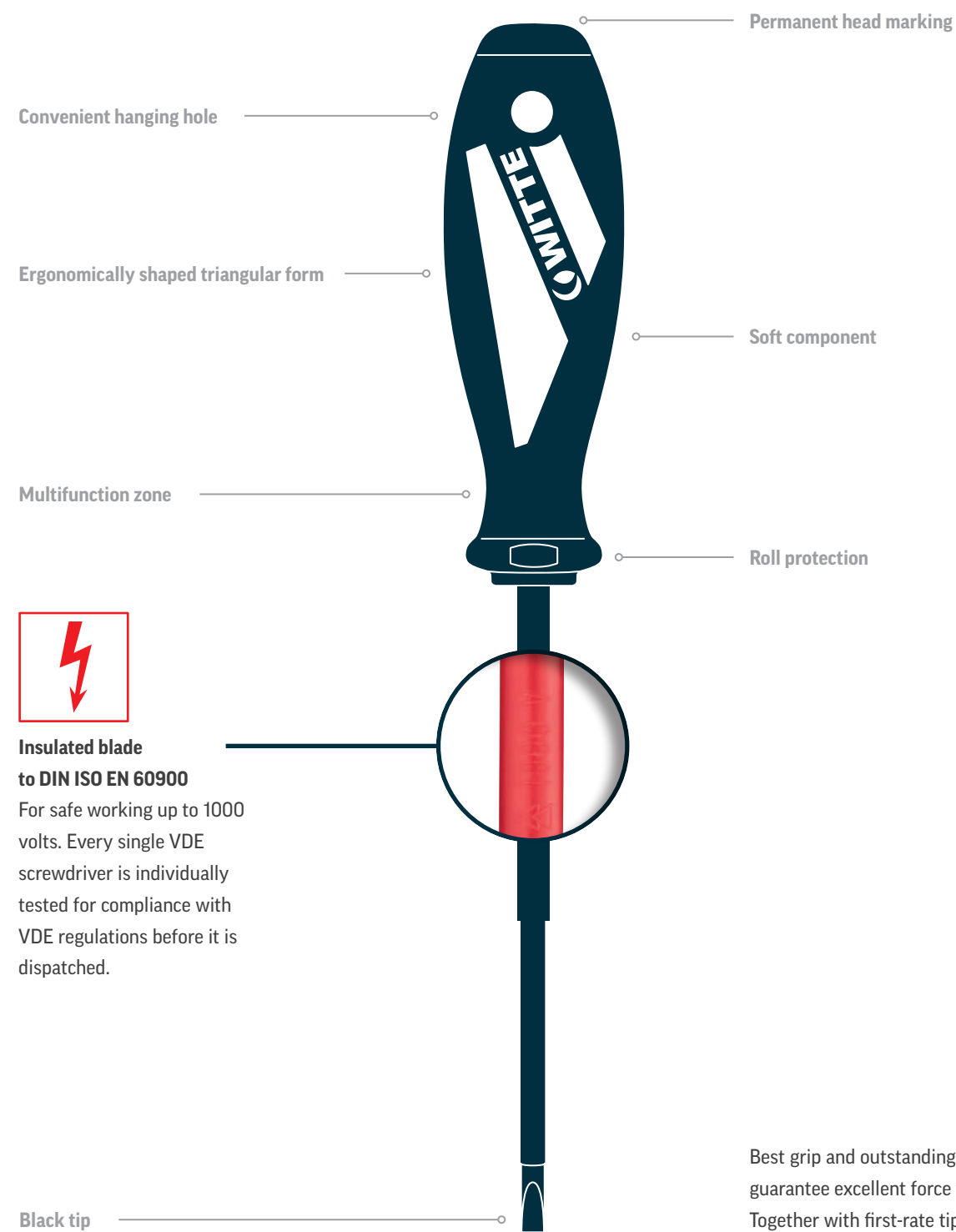

Best grip and outstanding ergonomic design guarantee excellent force transmission. Together with first-rate tips, this adds up to peak accuracy at the point of contact with the screw - even at voltages up to 1000 volts, because every individual screwdriver is tested in a dip-tank up to 10,000 volts in accordance with VDE requirements.

## 53700 slotted screwdrivers to ISO 2380



ITEM NO.	mm	mm	mm	mm	ITEM NO.	mm	mm	mm	mm
53701	0.4 x 2.5	75	2.5	103 x 23	53705	1.0 x 5.5	125	5.5	107 x 32
53702	0.5 x 3.0	100	3.0	103 x 23	53706	1.2 x 6.5	150	6.5	117 x 37
53703	0.6 x 3.5	100	3.5	103 x 23	53707	1.2 x 8.0	175	8.0	127 x 39
53704	0.8 x 4.0	100	4.0	107 x 32	53708	1.6 x 10.0	200	10.0	127 x 39

## 53710 PH screwdrivers tip to ISO 8764 for PHILLIPS recess screws



ITEM NO.		mm	mm	mm	ITEM NO.		mm	mm	mm
53710	PH 0	60	3.0	103 x 23	53713	PH 3	150	8.0	127 x 39
53711	PH 1	80	4.5	107 x 32	53714	PH 4	200	10.0	127 x 39
53712	PH 2	100	6.0	117 x 37					

## 53740 MODUL PH screwdrivers for +/- screws in electrical installations



ITEM NO.		mm	mm	mm	ITEM NO.		mm	mm	mm
53741	PH 1 / MODUL	80	4.5	107 x 32	53742	PH 2 / MODUL	100	6.0	117 x 37

## 53720 PZ screwdrivers tip to ISO 8764 for POZIDRIV screws



ITEM NO.		mm	mm	mm	ITEM NO.		mm	mm	mm
53720	PZ 0	60	3.0	103 x 23	53723	PZ 3	150	8.0	127 x 39
53721	PZ 1	80	4.5	107 x 32	53724	PZ 4	200	10.0	127 x 39
53722	PZ 2	100	6.0	117 x 37					

## 53760 MODUL PZ screwdrivers for +/- screws in electrical installations



ITEM NO.		mm	mm	mm
53761	PZ 1 / MODUL	80	4.5	107 x 32
53762	PZ 2 / MODUL	100	6.0	117 x 37

## 53730 TORX® screwdrivers



ITEM NO.		mm	mm	mm	ITEM NO.		mm	mm	mm	
53731	T 10	60	3.0	103 x 23	M 3.0	53735	T 30	100	6.0	117 x 37
53732	T 15	75	3.5	103 x 23	M 3.5	53736	T 40	150	8.0	127 x 39
53733	T 20	100	4.0	107 x 32	M 4.0	53737	T 45	150	8.0	127 x 39
53734	T 25	100	4.5	107 x 32	M 5.0					M 8.0-10.0

## 53750 nutdrivers



ITEM NO.		mm	mm	mm	ITEM NO.		mm	mm	mm
53750	6	125	5.0	117 x 37	53754	10	125	6.0	117 x 37
53751	7	125	6.0	117 x 37	53755	11	125	8.0	127 x 39
53752	8	125	6.0	117 x 37	53756	12	125	8.0	127 x 39
53753	9	125	6.0	117 x 37	53757	13	125	8.0	127 x 39

## 54810 Square drive screwdrivers for Robertson screws



ITEM NO.		mm	mm	mm
54811	1	80	4.5	107 x 32
54812	2	100	6.0	117 x 37



## Sets of screwdrivers

### 6-pcs. set

Order no. 653742

ITEM NO.	Drive	mm	mm
53701	●	0.4 x 2.5	75
53704	●●	0.8 x 4.0	100
53705	●●●	1.0 x 5.5	125
53706	●●●●	1.2 x 6.5	150
53711	⊕	PH 1	80
53712	⊕	PH 2	100

### 6-pcs. set

Order no. 653749

ITEM NO.	Drive	mm	mm
53701	●	0.4 x 2.5	75
53704	●●	0.8 x 4.0	100
53705	●●●	1.0 x 5.5	125
53706	●●●●	1.2 x 6.5	150
53721	⊕	PZ 1	80
53722	⊕	PZ 2	100

### 5-pcs. set

Order no. 653741

ITEM NO.	Drive	mm	mm
53701	●	0.4 x 2.5	75
53704	●●	0.8 x 4.0	100
53705	●●●	1.0 x 5.5	125
53711	⊕	PH 1	80
53712	⊕	PH 2	100

### 5-pcs. set

Order no. 653744

ITEM NO.	Drive	mm	mm
53701	●	0.4 x 2.5	75
53704	●●	0.8 x 4.0	100
53705	●●●	1.0 x 5.5	125
53721	⊕	PZ 1	80
53722	⊕	PZ 2	100

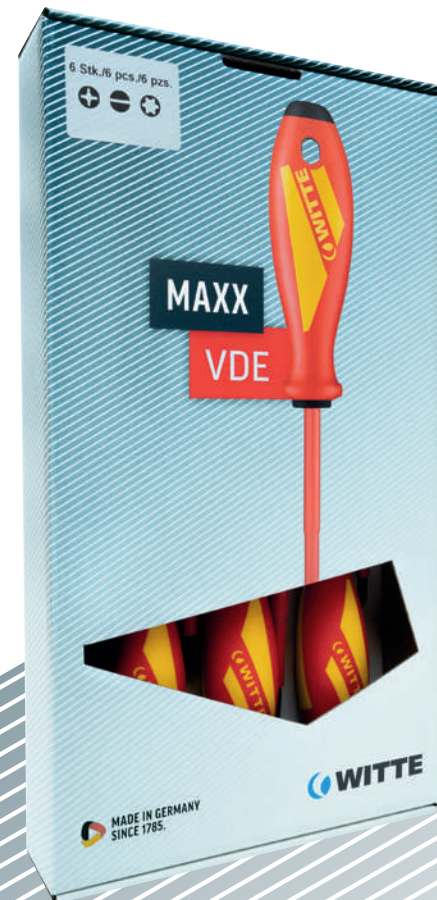



MAXX

VDE Slim



**Certified as ergonomic.**  
Tested by the independent  
IGR Institute for Health and  
Ergonomics

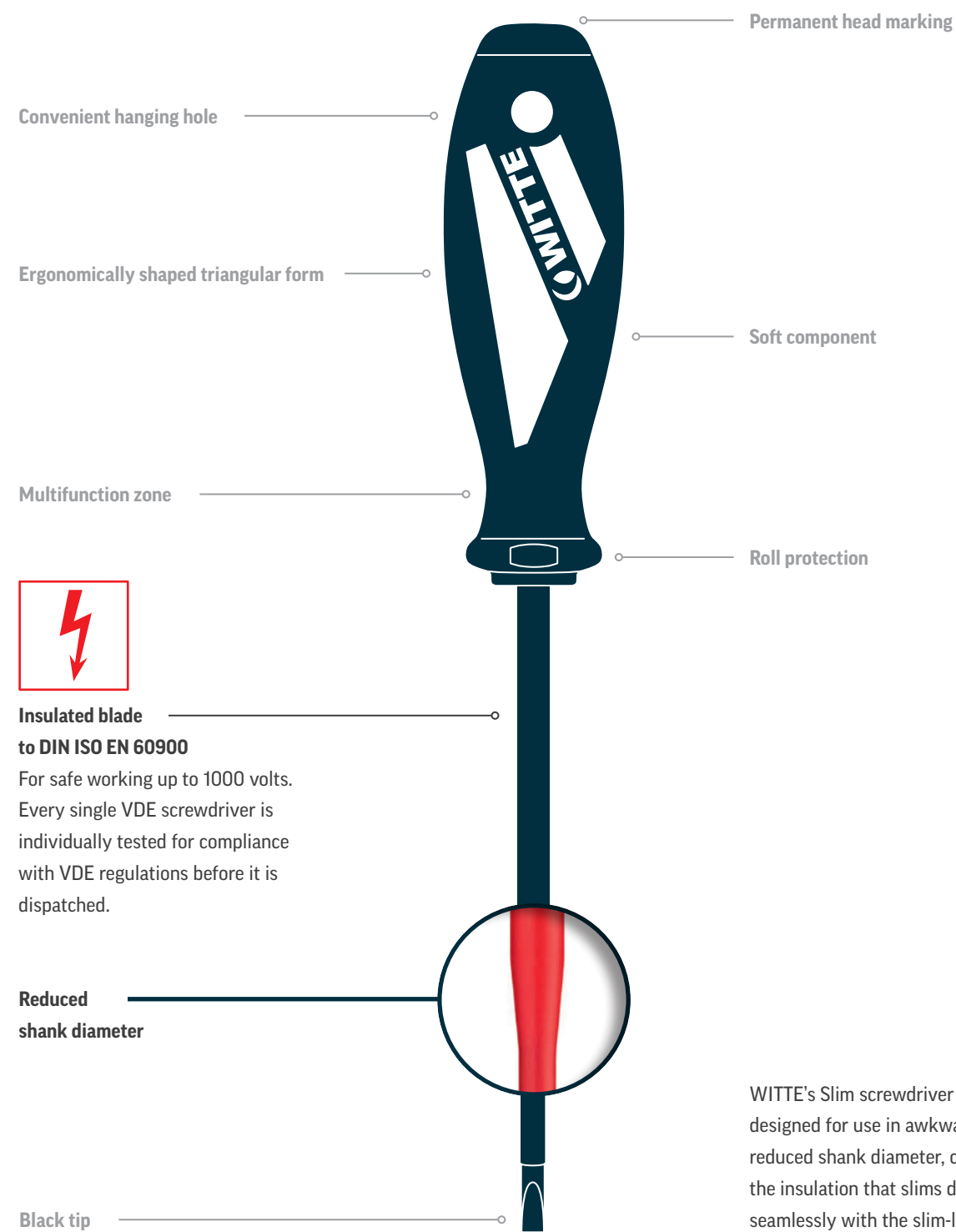







**Insulated blade to DIN ISO EN 60900**  
For safe working up to 1000 volts.  
Every single VDE screwdriver is  
individually tested for compliance  
with VDE regulations before it is  
dispatched.

WITTE's Slim screwdriver variants are designed for use in awkward spots. The reduced shank diameter, coupled with the insulation that tapers to blend seamlessly with the slim-line tip, ensures maximum access to screws that are often almost impossible to reach. By using the MAXX VDE slim tools, recessed screws and springs in live components can easily and safely be operated.





### 53900 slotted screwdrivers to ISO 2380



ITEM NO.	 mm	 mm	 mm	ITEM NO.	 mm	 mm	 mm	 mm
53903	0.6 x 3.5	100	3.5	53905	1.0 x 5.5	125	5.5	107 x 37
53904	0.8 x 4.0	100	4.0	53906	1.2 x 6.5	150	6.5	117 x 37
53909	0.8 x 4.5	175	4.5					





### 53910 PH screwdrivers tip to ISO 8764 for PHILLIPS recess screws



ITEM NO.		 mm	 mm	 mm
53911	PH 1	80	4.5	107 x 32
53912	PH 2	100	6.0	117 x 37





### 53940 MODUL PH screwdrivers for +/- screws in electrical installations



ITEM NO.		 mm	 mm	 mm
53941	PH 1 / MODUL	80	4.5	107 x 32
53942	PH 2 / MODUL	100	6.0	117 x 37





### 53920 PZ screwdrivers tip to ISO 8764 for POZIDRIV screws



ITEM NO.		 mm	 mm	 mm
53921	PZ 1	80	4.5	107 x 32
53922	PZ 2	100	6.0	117 x 37





### 53760 MODUL PZ screwdrivers for +/- screws in electrical installations



ITEM NO.		 mm	 mm	 mm
53961	PZ 1 / MODUL	80	4.5	107 x 32
53962	PZ 2 / MODUL	100	6.0	117 x 37







### 53970 Square drive screwdrivers for Robertson screws









ITEM NO.	 mm	 mm	 mm	 mm
53971	1.0	100	4.5	107 x 32
53972	2.0	125	5.0	107 x 32

### Sets of screwdrivers







#### 5-pcs. set Order no. 653771

ITEM NO.	Drive	mm	 mm
53903		0.6 x 3.5	100
53904		0.8 x 4.0	100
53905		1.0 x 5.5	125
53911		PH 1	80
53912		PH 2	100









#### 5-pcs. set Order no. 653772

ITEM NO.	Drive	mm	 mm
53903		0.6 x 3.5	100
53904		0.8 x 4.0	100
53905		1.0 x 5.5	125
53921		PZ 1	80
53922		PZ 2	100

#### 6-pcs. set Order no. 653773

ITEM NO.	Drive	mm	 mm
53903		0.6 x 3.5	100
53904		0.8 x 4.0	100
53905		1.0 x 5.5	125
53906		1.2 x 6.5	150
53911		PH 1	80
53912		PH 2	100

#### 7-pcs. set Order no. 653774

ITEM NO.	Drive	mm	 mm
53701		0.4 x 2.5	75
53904		0.8 x 4.0	100
53906		1.2 x 6.5	150
53971		1.0	100
53972		2.0	125
53911		PH 1	80
53912		PH 2	100





**MAXX**

voltage tester

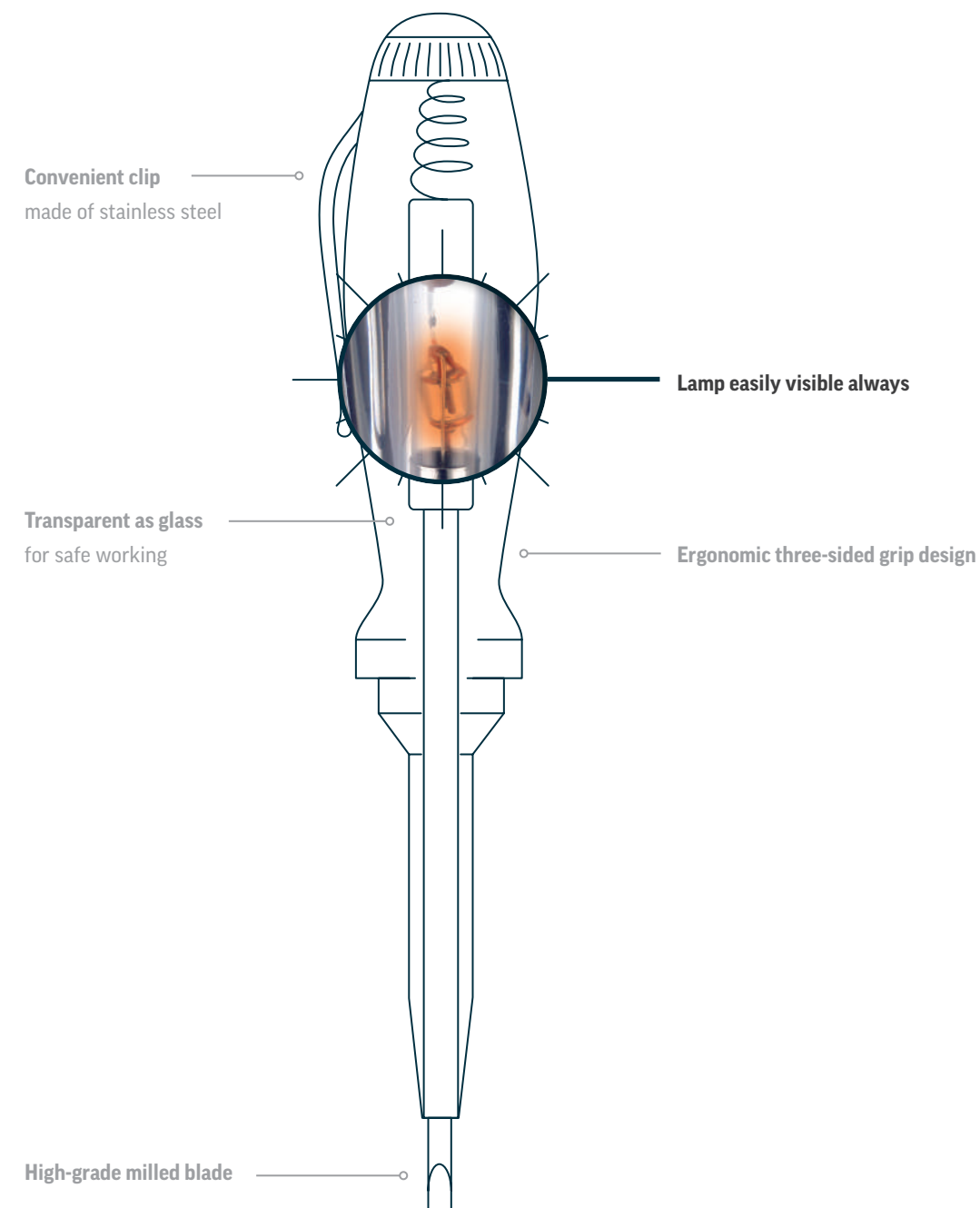
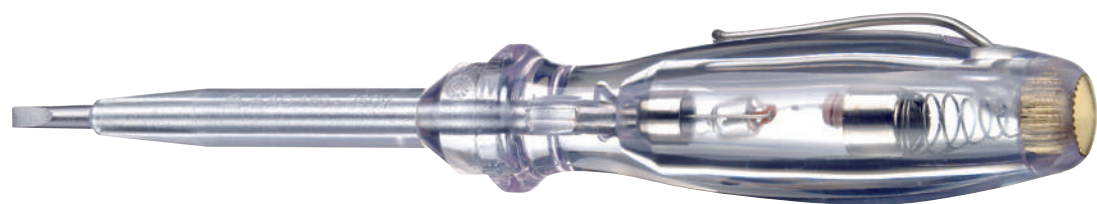

MAXX voltage tester – safety first. The smooth handle, as transparent as glass, allows an unhindered view of the glowing lamp inside the handle from any position. For maximum safety. The voltage tester has been manufactured in accordance with the current DIN standard and tested to VDE/GS (German label for tested safety) for work on live components from 150-250 volts.





**24090 voltage tester**

tested to VDE 0680 Part 6



150-250 volts



ITEM NO.	 mm	 mm	 mm	 mm
24090	3.0	65	88 x 21	153





# MAXXPRO

## Stainless



**Certified as ergonomic.**  
Tested by the independent  
IGR Institute for Health and  
Ergonomics

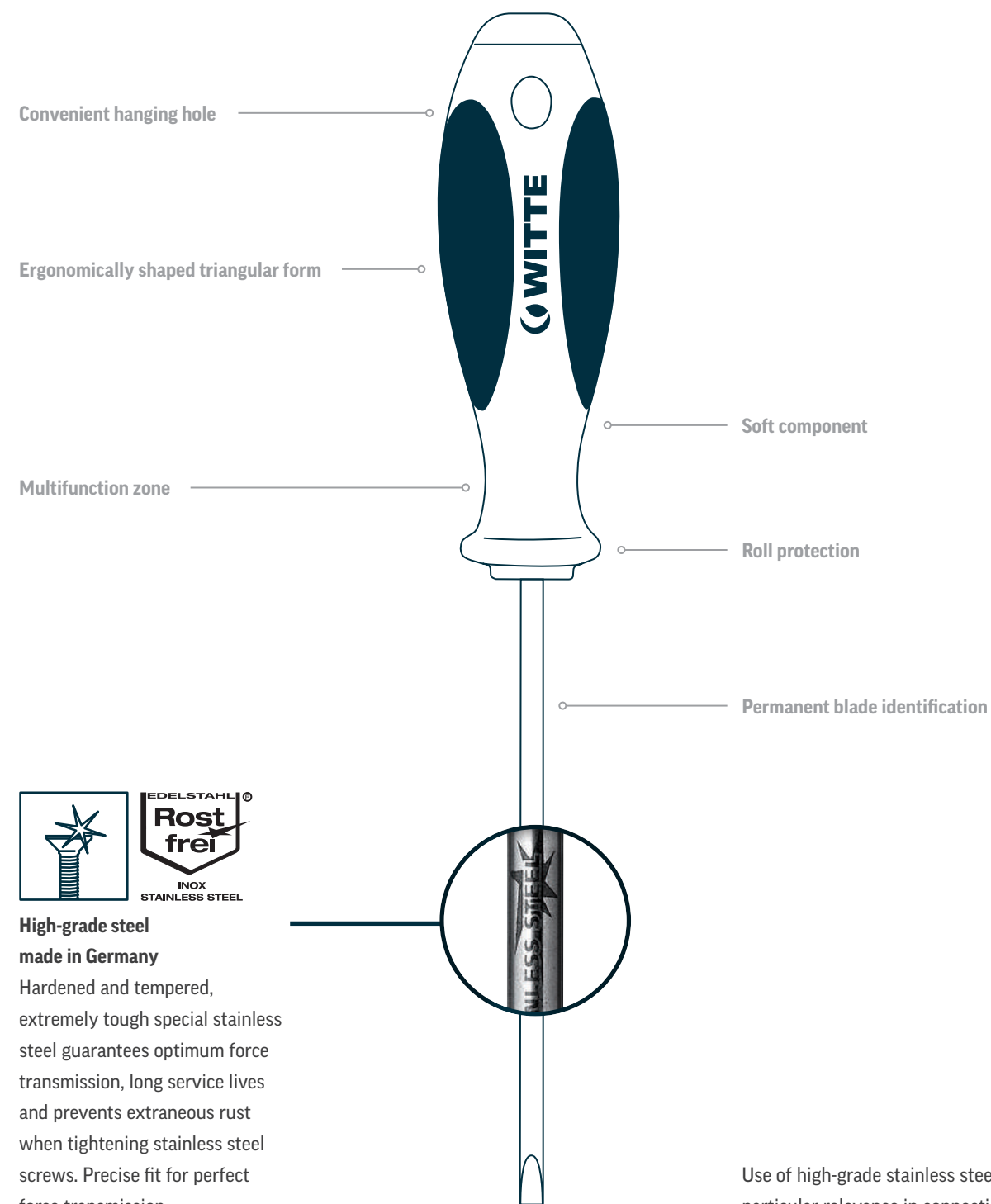



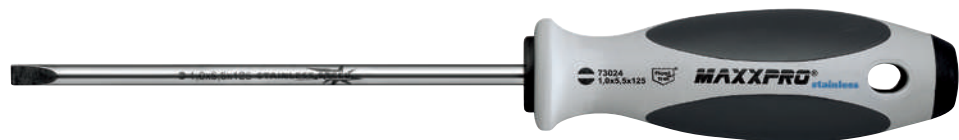

Use of high-grade stainless steel is of particular relevance in connection with stainless steel fastening jobs. This is the only way to prevent extraneous rust and pitting corrosion which occur if conventional steel screwdrivers are used. This is where quality comes first.

## 73020 slotted screwdrivers

to DIN 5264 and ISO 2380





ITEM NO.	 mm	 mm	 mm	 mm
73021	0.5 x 3.0	75	3.0	103 x 23
73023	0.8 x 4.0	100	4.0	103 x 23
73024	1.0 x 5.5	125	5.5	107 x 32
73025	1.2 x 6.5	150	6.5	117 x 37

## 73030 PH screwdrivers

to ISO 8764 for PHILLIPS recess screws





ITEM NO.	 mm	 mm	 mm
73032	PH 1 80	4.5	107 x 32
73035	PH 2 100	6.0	117 x 37
73038	PH 3 150	8.0	117 x 37

## 73040 PZ screwdrivers



to ISO 8764 for POZIDRIV screws



ITEM NO.	 mm	 mm	 mm
73042	PZ 1 80	4.5	107 x 32
73045	PZ 2 100	6.0	117 x 37
73048	PZ 3 150	8.0	117 x 37

## 73200 TORX® screwdrivers









ITEM NO.	 mm	 mm	 mm
73206	T 10 80	3.5	103 x 23
73207	T 15 80	3.5	103 x 23
73208	T 20 100	4.5	107 x 32
73209	T 25 100	4.5	107 x 32
73211	T 30 115	6.0	117 x 37
73212	T 40 115	8.0	117 x 37

## Sets of screwdrivers







### 6-pcs. set

Order no. 670007

ITEM NO.	Drive	mm	 mm
73021		0.5 x 3.0	75
73023		0.8 x 4.0	100
73024		1.0 x 5.5	125
73025		1.2 x 6.5	150
73032		PH 1	80
73035		PH 2	100







### 6-pcs. set

Order no. 670006

ITEM NO.	Drive	mm	 mm
73021		0.5 x 3.0	75
73023		0.8 x 4.0	100
73024		1.0 x 5.5	125
73025		1.2 x 6.5	150
73042		PZ 1	80
73045		PZ 2	100







### 6-pcs. set

Order no. 670008

ITEM NO.	Drive		 mm
73206		T 10	80
73207		T 15	80
73208		T 20	100
73209		T 25	100
73211		T 30	115
73212		T 40	115







### 5-pcs. set

Order no. 670002

ITEM NO.	Drive	mm	 mm
73021		0.5 x 3.0	75
73023		0.8 x 4.0	100
73024		1.0 x 5.5	125
73032		PH 1	80
73035		PH 2	100

### 5-pcs. set

Order no. 670001

ITEM NO.	Drive	mm	 mm
73021		0.5 x 3.0	75
73023		0.8 x 4.0	100
73024		1.0 x 5.5	125
73042		PZ 1	80
73045		PZ 2	100



# MAXXPRO

## Nature

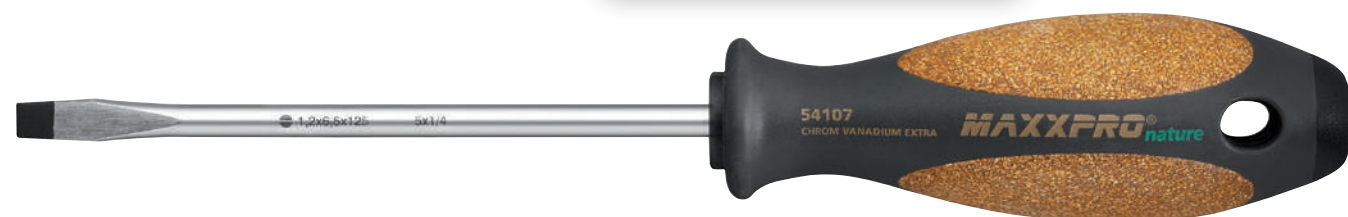

**Certified as ergonomic.**  
Tested by the independent  
IGR Institute for Health and  
Ergonomics

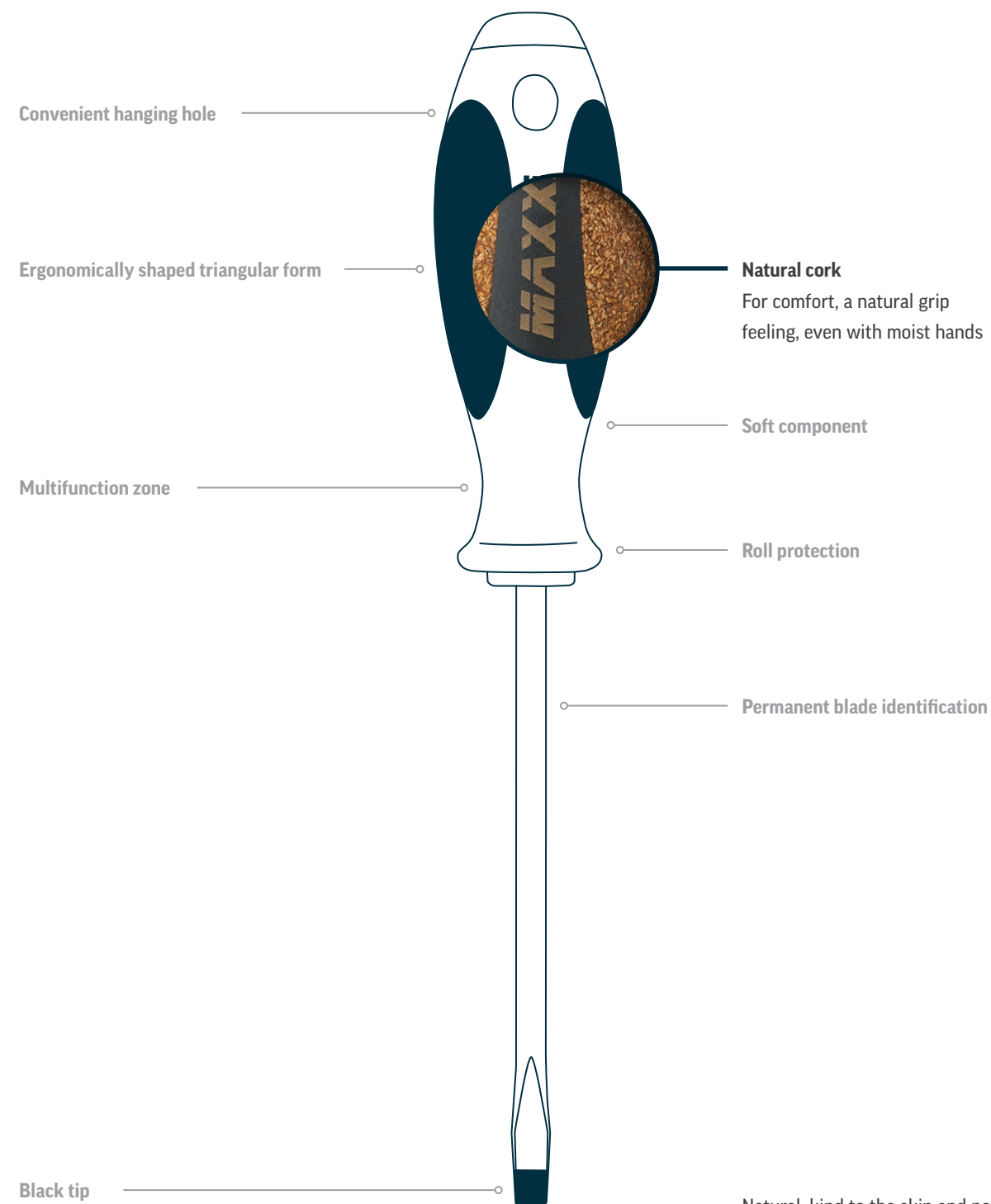



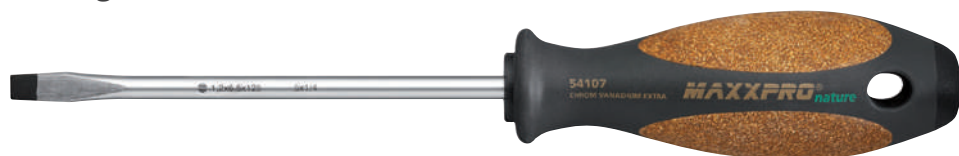

Natural, kind to the skin and non-slip: moisture-absorbent cork components in the grip give the MAXXPRO tools a satisfying feel and good tactile feedback. In conjunction with excellent ergonomic design, they ensure first-class force transmission.

## 54100 slotted keystone / engineer's screwdrivers

to DIN 5264 and ISO 2380





ITEM NO.	 mm	 mm	 mm	 mm
54103	0.8 x 4.0	75	4.0	107 x 32
54105	1.0 x 5.5	100	5.0	107 x 32
54107	1.2 x 6.5	125	6.0	117 x 37

## 54030 PH screwdrivers

to ISO 8764 for PHILLIPS recess screws





ITEM NO.	 mm	 mm	 mm
54032	PH 1 80	4.5	107 x 32
54035	PH 2 100	6.0	117 x 37

## 54040 PZ screwdrivers

to ISO 8764 for POZIDRIV screws



ITEM NO.	 mm	 mm	 mm
54042	PZ 1 80	4.5	107 x 32
54045	PZ 2 100	6.0	117 x 37

## 969 bottle-opener



ITEM NO.	 mm
969	117 x 37

## Sets of screwdrivers













in environmentally friendly carton

### 5-pcs. set

Order no. 654865

### 5-pcs. set

Order no. 654866

ITEM NO.	Drive	mm	 mm	ITEM NO.	Drive	mm	 mm
54103		0.8 x 4.0	75	54103		0.8 x 4.0	75
54105		1.0 x 5.5	100	54105		1.0 x 5.5	100
54107		1.2 x 6.5	125	54107		1.2 x 6.5	125
54032		PH 1	80	54042		PZ 1	80
54035		PH 2	100	54045		PZ 2	100



# MAXXPRO

## Women Line



**Certified as ergonomic.**  
Tested by the independent  
IGR Institute for Health and  
Ergonomics

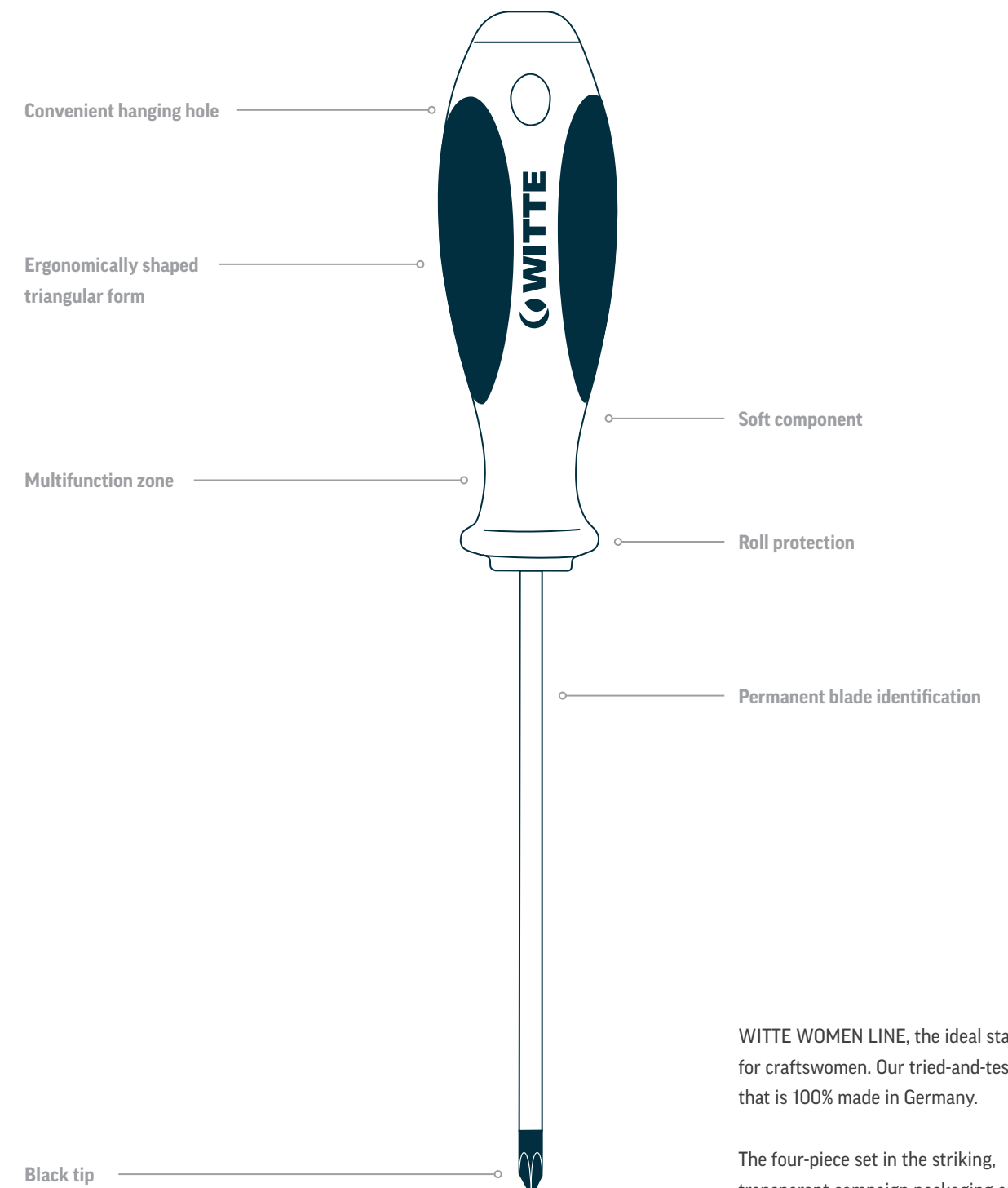

WITTE WOMEN LINE, the ideal starter set for craftswomen. Our tried-and-tested quality that is 100% made in Germany.

The four-piece set in the striking, transparent campaign packaging appeals to professional craftswomen with its attractive colouring and optimised handle sizes. In addition, the triangular shaped grips typical of WITTE ensure improved force application and secure grip in the palm of the hand.

## 654005 WOMEN LINE screwdriver set

**4-pcs. set**  
Order no. 654005



Drive		mm
	1.2 x 6.5	125
	PH 1	80
	PZ 2	100
	Voltage tester SB 3.0 x 65	65



Transparent sliding box  
Allows you to see the tools inside.





















**PRO**

# Screwdrivers



## 56 Screwdrivers

Universal screwdrivers at a glance

58	PRO	
68	PRO Plus	
72	PRO Impact	
76	PRO VDE	
80	PRO VDE Slim	
84	PRO BITDRIVE®	
88	PRO BITDRIVE® RATCHET	
92	PRO BITDRIVE® TORQUE	
96	PRO BITDRIVE® TORQUE VDE	
100	PRO ESD	
104	PRO voltage testers	
108	PRO Nature	
112	PRO T-bar	
116	PRO WITTRON®	
122	PRO WITTRON® VDE	
126	PRO WITTRON® ESD	
132	PRO Allen keys	



# PRO

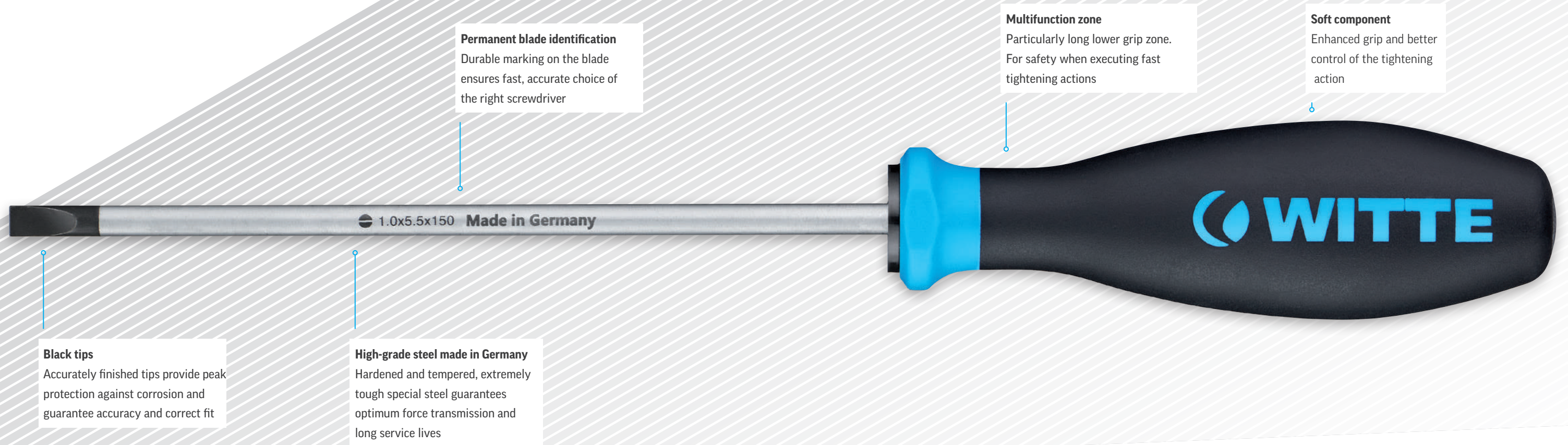

**Permanent blade identification**  
Durable marking on the blade ensures fast, accurate choice of the right screwdriver

**Multifunction zone**  
Particularly long lower grip zone. For safety when executing fast tightening actions

**Soft component**  
Enhanced grip and better control of the tightening action

**Black tips**  
Accurately finished tips provide peak protection against corrosion and guarantee accuracy and correct fit

**High-grade steel made in Germany**  
Hardened and tempered, extremely tough special steel guarantees optimum force transmission and long service lives

In daily work environments, the **PRO** quality series of tools prove their worth over and over again, in particular due to their ergonomic handle shape in conjunction with hardened and tempered special steel. The seamless combination of hard and soft grip materials enhances force transmission, makes handling the tool more satisfactory and reduces strain.

upper grip zone enables force to be applied more effectively. **The round cross-section** in the central section combines firm grip with easier turning in the spin zone. **The extended multifunction zone** in the lower grip zone promotes faster tightening and loosening action. The three grip zones combine to form a sculpted longitudinal contour and to optimise contact pressure.

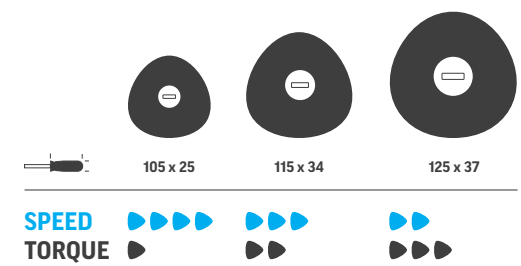

The comparison in the illustration shows that the handle sizes of the WITTE Pro series of screwdrivers are perfectly matched to the fastener sizes.

- The advantages**
- Optimised force transmission and less work effort due to ergonomically designed handles
  - Matt chrome-plated, permanently marked blades made of hardened and tempered special steel in all profiles
  - Black tips guarantee peak accuracy and correct fit
  - Long-term satisfaction with your tools thanks to premium quality »made in Germany«

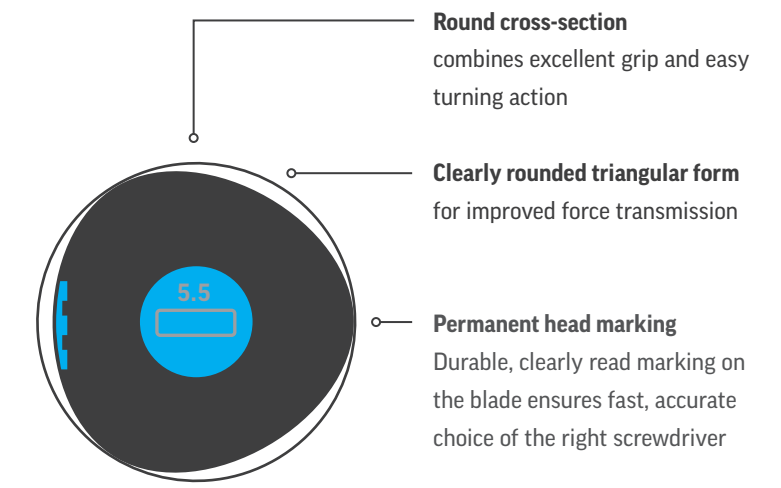



## 87200 slotted keystone/engineer's screwdrivers

to DIN 5264 and ISO 2380



ITEM NO.	mm	mm	mm	mm	ITEM NO.	mm	mm	mm	mm
87201	0.6 x 3.5	75	3.5	105 x 25	87207	1.2 x 6.5	125	6.0	115 x 34
87202	0.6 x 3.5	100	3.5	105 x 25	87208	1.2 x 6.5	150	6.0	115 x 34
87203	0.8 x 4.0	75	4.0	105 x 25	87209	1.2 x 8.0	150	7.0	125 x 37
87204	0.8 x 4.0	100	4.0	105 x 25	87210	1.6 x 8.0	175	7.0	125 x 37
87205	1.0 x 5.5	100	5.0	115 x 34	87211	1.6 x 10.0	200	8.0	125 x 37
87206	1.0 x 5.5	125	5.0	115 x 34					

## 86790 slotted cabinet / electrician's screwdrivers

to DIN 5264 and ISO 2380



ITEM NO.	mm	mm	mm	mm	ITEM NO.	mm	mm	mm	mm
86791	0.5 x 3.0	75	3.0	105 x 25	86795	1.0 x 5.5	150	5.5	115 x 34
86792	0.6 x 3.5	100	3.5	105 x 25	86796	1.0 x 5.5	200	5.5	115 x 34
86793	0.8 x 4.0	125	4.0	105 x 25	86797	1.0 x 5.5	300	5.5	115 x 34
86794	0.6 x 4.0	300	4.0	105 x 25					

## 94800 PH screwdrivers

to ISO 8764 for PHILLIPS recess screws



ITEM NO.		mm	mm	mm	ITEM NO.		mm	mm	mm
94801	PH 0	60	3.0	105 x 25	94809	PH 2	200	6.0	115 x 34
94802	PH 1	80	4.5	105 x 25	94805	PH 2	300	6.0	115 x 34
94803	PH 1	300	4.5	105 x 25	94806	PH 3	150	8.0	125 x 37
94804	PH 2	100	6.0	115 x 34	94807	PH 4	200	10.0	125 x 37
94808	PH 2	150	6.0	115 x 25					

## 99600 PZ screwdrivers

to ISO 8764 for POZIDRIV screws



ITEM NO.		mm	mm	mm	ITEM NO.		mm	mm	mm
99601	PZ 0	60	3.0	105 x 25	99605	PZ 2	300	6.0	115 x 34
99602	PZ 1	80	4.5	105 x 25	99606	PZ 3	150	8.0	125 x 37
99603	PZ 1	300	4.5	105 x 27	99607	PZ 4	200	10.0	125 x 37
99604	PZ 2	100	6.0	115 x 34					

## 98900 TORX® screwdrivers



ITEM NO.		mm	mm	mm	ITEM NO.		mm	mm	mm
98901	T 5	60	3.0	105 x 25	98908	T 20	100	4.5	105 x 25
98902	T 6	60	3.0	105 x 25	98909	T 25	100	4.5	105 x 25
98903	T 7	60	3.0	105 x 25	98910	T 27	115	6.0	115 x 34
98904	T 8	60	3.0	105 x 25	98911	T 30	115	6.0	115 x 34
98905	T 9	60	3.0	105 x 25	98912	T 40	115	7.0	125 x 37
98906	T 10	80	3.5	105 x 25	98913	T 45	130	8.0	125 x 37
98907	T 15	80	3.5	105 x 25					

## 99300 TORX® screwdrivers

with central bore, tamper resistant



ITEM NO.		mm	mm	mm	ITEM NO.		mm	mm	mm
99303	TR 7	60	3.0	105 x 25	99309	TR 25	100	4.5	105 x 25
99304	TR 8	60	3.0	105 x 25	99310	TR 27	115	6.0	115 x 34
99305	TR 9	60	3.0	105 x 25	99311	TR 30	115	6.0	115 x 34
99306	TR 10	80	3.5	105 x 25	99312	TR 40	115	7.0	125 x 37
99307	TR 15	80	3.5	105 x 25	99313	TR 45	130	8.0	125 x 37
99308	TR 20	100	4.5	105 x 25					

## 93000 Square drive screwdrivers

for Robertson screws



ITEM NO.		mm	mm	mm
93001	1.0	100	4.5	105 x 25
93002	2.0	125	5.0	115 x 34
93003	3.0	150	6.0	115 x 34

## 98700 nutdrivers



ITEM NO.		mm	mm	ITEM NO.		mm	mm
98701	3.5	125	105 x 25	98709	9.0	125	115 x 34
98702	4.0	125	105 x 25	98710	10.0	125	115 x 34
98703	4.5	125	105 x 25	98711	11.0	125	125 x 37
98704	5.0	125	105 x 25	98712	12.0	125	125 x 37
98705	5.5	125	105 x 25	98713	13.0	125	125 x 37
98706	6.0	125	115 x 34	98714	14.0	125	125 x 37
98707	7.0	125	115 x 34	98715	17.0	125	125 x 37
98708	8.0	125	115 x 34				

## 98800 nutdrivers

with flexible shank



ITEM NO.	Hex	mm	mm	ITEM NO.	Hex	mm	mm
98801	5.0	210	115 x 34	98805	8.0	210	115 x 34
98802	5.5	210	115 x 34	98806	10.0	210	115 x 34
98803	6.0	210	115 x 34	98807	1/4"	210	115 x 34
98804	7.0	210	115 x 34				

## 26375 bitholder

with 150 mm blade and permanent magnet



ITEM NO.	Hex	mm	mm
26375	1/4"	150	115 x 34

## 87230 slotted stubby screwdriver



ITEM NO.	mm	mm	mm	mm
87231	0.8 x 4.5	25	4.5	55 x 25
87232	1.0 x 6.0	25	6.0	55 x 25
87233	1.2 x 8.0	25	8.0	55 x 25

## 94350 PH stubby screwdriver

to ISO 8764 for PHILLIPS recess screws



ITEM NO.	PH	mm	mm	mm
94351	PH 1	25	4.5	55 x 25
94352	PH 2	25	6.0	55 x 25

## 95190 PZ stubby screwdriver

to ISO 8764 for POZIDRIV screws



ITEM NO.	PZ	mm	mm	mm
95191	PZ 1	25	4.5	55 x 25
95192	PZ 2	25	6.0	55 x 25

## 970 bottle-opener



ITEM NO.	mm
970	115 x 34

## 92542 awl

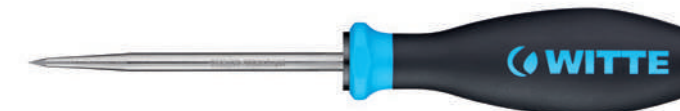

ITEM NO.	mm	mm	mm
92542	100	6.0	115 x 34

## 92551 square reamer

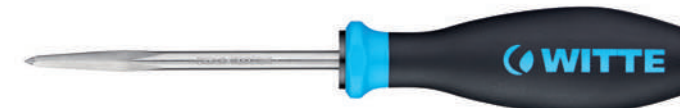

ITEM NO.	mm	mm	mm
92551	100	6.0	115 x 34



Sets of screwdrivers



Market-orientated tool sets  
Exactly what customers want. Compiled through many years' observation of practical applications.

**6-pcs. set**  
Order no. 670030

ITEM NO.	Drive	mm	mm
87205	●	1.0 x 5.5	100
87207	●	1.2 x 6.5	125
94802	⊕	PH 1	80
94804	⊕	PH 2	100
99602	⊕	PZ 1	80
99604	⊕	PZ 2	100

**6-pcs. set**  
Order no. 670031

ITEM NO.	Drive	mm	mm
86791	●	0.5 x 3.0	75
87204	●	0.8 x 4.0	100
87206	●	1.0 x 5.5	125
87208	●	1.2 x 6.5	150
94802	⊕	PH 1	80
94804	⊕	PH 2	100

**6-pcs. set**  
Order no. 670032

ITEM NO.	Drive	mm	mm
86791	●	0.5 x 3.0	75
87204	●	0.8 x 4.0	100
87206	●	1.0 x 5.5	125
87208	●	1.2 x 6.5	150
99602	⊕	PZ 1	80
99604	⊕	PZ 2	100

**6-pcs. set**  
Order no. 670033

ITEM NO.	Drive	mm	mm
87203	●	0.8 x 4.0	75
87205	●	1.0 x 5.5	100
87207	●	1.2 x 6.5	125
87209	●	1.2 x 8.0	150
94802	⊕	PH 1	80
94804	⊕	PH 2	100

**6-pcs. set**  
Order no. 670034

ITEM NO.	Drive	mm	mm
87203	●	0.8 x 4.0	75
87205	●	1.0 x 5.5	100
87207	●	1.2 x 6.5	125
87209	●	1.2 x 8.0	150
99602	⊕	PZ 1	80
99604	⊕	PZ 2	100

**6-pcs. set**  
Order no. 670037

ITEM NO.	Drive	mm	mm
98906	⊕	T 10	80
98907	⊕	T 15	80
98908	⊕	T 20	100
98909	⊕	T 25	100
98911	⊕	T 30	115
98912	⊕	T 40	115

**6-pcs. set**  
Order no. 670038

ITEM NO.	Drive	mm	mm
99306	⊕	TR 10	80
99307	⊕	TR 15	80
99308	⊕	TR 20	100
99309	⊕	TR 25	100
99311	⊕	TR 30	115
99312	⊕	TR 40	115

**5-pcs. set**  
Order no. 670039

ITEM NO.	Drive	mm	mm
87203	●	0.8 x 4.0	75
87205	●	1.0 x 5.5	100
87207	●	1.2 x 6.5	125
94802	⊕	PH 1	80
94804	⊕	PH 2	100

**5-pcs. set**  
Order no. 670040

ITEM NO.	Drive	mm	mm
87203	●	0.8 x 4.0	75
87205	●	1.0 x 5.5	100
87207	●	1.2 x 6.5	125
99602	⊕	PZ 1	80
99604	⊕	PZ 2	100







PRO

Plus

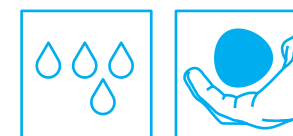

**Patented, non-slip  
microfibre coating**

Guarantees better grip and less  
slippage even with oily or moist  
hands

Roll protection

Black tip

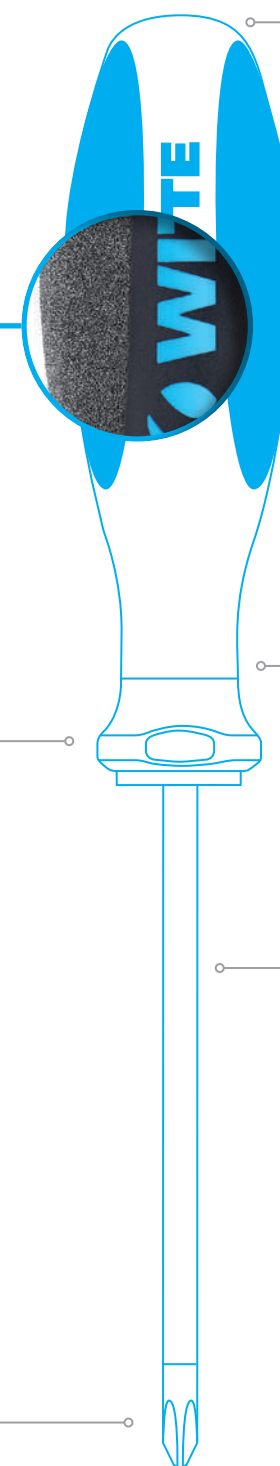

Permanent head marking

Multifunction zone

Permanent blade identification

Unbeatable force transmission and efficacy  
with the PRO series: perfected ergonomic  
design and generously dimensioned, firm-grip  
microfibre surface guarantee particularly  
good force transmission. The innovative  
multifunction zone complements this by  
ensuring greater efficiency as you work.

## 87300 slotted keystone/engineer's screwdrivers

to DIN 5264 and ISO 2380



ITEM NO.	mm	mm	mm	mm	ITEM NO.	mm	mm	mm	mm
87303	0.8 x 4.0	75	4.0	105 x 25	87308	1.2 x 6.5	150	6.0	115 x 34
87304	0.8 x 4.0	100	4.0	105 x 25	87309	1.2 x 8.0	150	7.0	125 x 37
87305	1.0 x 5.5	100	5.0	115 x 34	87310	1.6 x 8.0	175	7.0	125 x 37
87306	1.0 x 5.5	125	5.0	115 x 34	87311	1.6 x 10.0	200	8.0	125 x 37
87307	1.2 x 6.5	125	6.0	115 x 34					

## 86890 slotted cabinet / electrician's screwdrivers

to DIN 5264 and ISO 2380



ITEM NO.	mm	mm	mm	mm	ITEM NO.	mm	mm	mm	mm
86893	0.8 x 4.0	125	4.0	105 x 25	86896	1.0 x 5.5	200	5.5	115 x 34
86894	0.6 x 4.0	300	4.0	105 x 25	86897	1.0 x 5.5	300	5.5	115 x 34
86895	1.0 x 5.5	150	5.5	115 x 34					

## 94900 PH screwdrivers

tip to ISO 8764 for PHILLIPS recess screws



ITEM NO.	Drive	mm	mm	mm	ITEM NO.	Drive	mm	mm	mm
94902	PH 1	80	4.5	105 x 25	94905	PH 2	300	6.0	115 x 34
94903	PH 1	300	4.5	105 x 25	94906	PH 3	150	8.0	125 x 37
94904	PH 2	100	6.0	115 x 34	94907	PH 4	200	10.0	125 x 37

## 99700 PZ screwdrivers

tip to ISO 8764 for POZIDRIV screws



ITEM NO.	Drive	mm	mm	mm	ITEM NO.	Drive	mm	mm	mm
99702	PZ 1	80	4.5	105 x 25	99705	PZ 2	300	6.0	115 x 34
99703	PZ 1	300	4.5	105 x 25	99706	PZ 3	150	8.0	125 x 37
99704	PZ 2	100	6.0	115 x 34	99707	PZ 4	200	10.0	125 x 37

## 99000 TORX® screwdrivers



ITEM NO.	Drive	mm	mm	mm	ITEM NO.	Drive	mm	mm	mm
99006	T 10	80	3.5	105 x 25	99010	T 27	115	6.0	115 x 34
99007	T 15	80	3.5	105 x 25	99011	T 30	115	6.0	115 x 34
99008	T 20	100	4.5	105 x 25	99012	T 40	115	7.0	125 x 37
99009	T 25	100	4.5	105 x 25	99013	T 45	130	8.0	125 x 37

## Sets of screwdrivers

### 6-pcs. set

Order no. 670060

ITEM NO.	Drive	mm	mm
87305	●	1.0 x 5.5	100
87307	●	1.2 x 6.5	125
94902	⊕	PH 1	80
94904	⊕	PH 2	100
99702	⊕	PZ 1	80
99704	⊕	PZ 2	100

### 6-pcs. set

Order no. 670063

ITEM NO.	Drive	mm	mm
87303	●	0.8 x 4.0	75
87305	●	1.0 x 5.5	100
87307	●	1.2 x 6.5	125
87309	●	1.2 x 8.0	150
94902	⊕	PH 1	80
94904	⊕	PH 2	100

### 6-pcs. set

Order no. 670064

ITEM NO.	Drive	mm	mm
87303	●	0.8 x 4.0	75
87305	●	1.0 x 5.5	100
87307	●	1.2 x 6.5	125
87309	●	1.2 x 8.0	150
99702	⊕	PZ 1	80
99704	⊕	PZ 2	100

### 6-pcs. set

Order no. 670067

ITEM NO.	Drive	mm	mm
99006	⊗	T 10	80
99007	⊗	T 15	80
99008	⊗	T 20	100
99009	⊗	T 25	100
99011	⊗	T 30	115
99012	⊗	T 40	115

### 5-pcs. set

Order no. 670069

ITEM NO.	Drive	mm	mm
87303	●	0.8 x 4.0	75
87305	●	1.0 x 5.5	100
87307	●	1.2 x 6.5	125
94902	⊕	PH 1	80
94904	⊕	PH 2	100

### 5-pcs. set

Order no. 670070

ITEM NO.	Drive	mm	mm
87303	●	0.8 x 4.0	75
87305	●	1.0 x 5.5	100
87307	●	1.2 x 6.5	125
99702	⊕	PZ 1	80
99704	⊕	PZ 2	100





**PRO**  
Impact

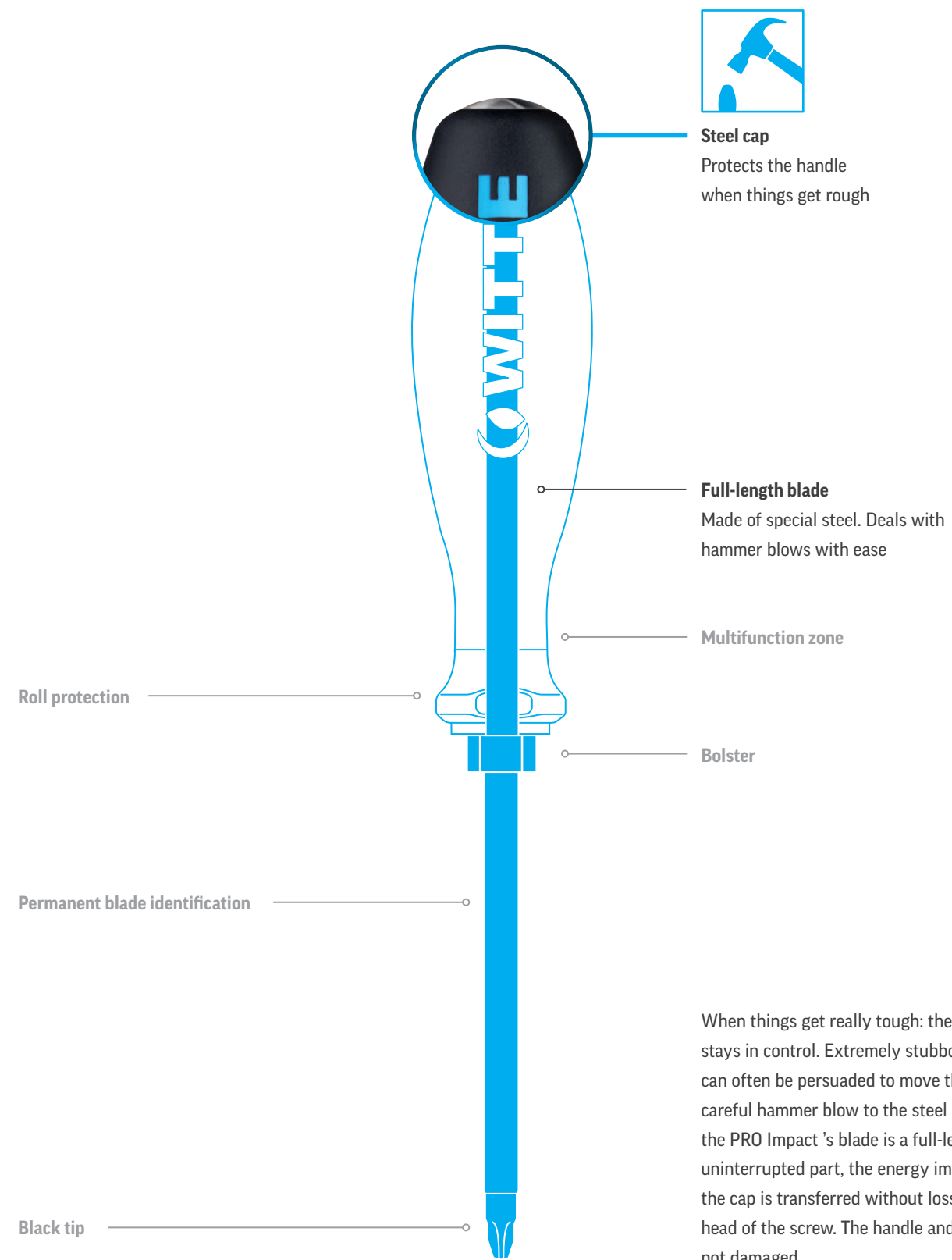

When things get really tough: the PRO Impact stays in control. Extremely stubborn screws can often be persuaded to move through a careful hammer blow to the steel cap. Since the PRO Impact's blade is a full-length, uninterrupted part, the energy imparted to the cap is transferred without loss to the head of the screw. The handle and blade are not damaged.

But that is not all: where additional torque is required, the PRO Impact has a hexagonal bolster and blade, so a spanner can be applied to increase the lever effect.

## 83800 slotted keystone/engineer's screwdrivers

to DIN 5264 and ISO 2380, hexagonal blade and bolster dimensionally accurate to DIN 475



ITEM NO.	mm	mm	mm	shank	mm
83802	0.8 x 4.0	90	8.0	5.0	105 x 25
83803	1.0 x 5.5	100	8.0	5.0	115 x 34
83804	1.2 x 6.5	125	10.0	6.0	115 x 34
83805	1.2 x 8.0	150	13.0	8.0	125 x 37
83806	1.6 x 10.0	175	13.0	8.0	125 x 37
83807	2.0 x 12.0	200	-	10.0	125 x 37
83808	2.5 x 14.0	250	-	10.0	125 x 37

## 83900 PH screwdrivers

to ISO 8764 for PHILLIPS recess screws, hexagonal blade and bolster dimensionally accurate to DIN 475



ITEM NO.	mm	mm	shank	mm
83901	PH 1 85	8.0	5.0	105 x 25
83902	PH 2 100	10.0	6.0	115 x 34
83903	PH 3 150	13.0	8.0	125 x 37

## 84000 PZ screwdrivers

to ISO 8764 for POZIDRIV screws, hexagonal blade and bolster dimensionally accurate to DIN 475



ITEM NO.	mm	mm	shank	mm
84001	PZ 1 85	8.0	5.0	105 x 25
84002	PZ 2 100	10.0	6.0	115 x 34
84003	PZ 3 150	13.0	8.0	125 x 37

## Sets of screwdrivers

### 6-pcs. set

Order no. 670094

ITEM NO.	Drive	mm	mm
83802		0.8 x 4.0	8 90
83803		1.0 x 5.5	8 100
83804		1.2 x 6.5	10 125
83805		1.2 x 8.0	13 150
83901		PH 1	8 80
83902		PH 2	10 100

### 6-pcs. set

Order no. 670095

ITEM NO.	Drive	mm	mm
83802		0.8 x 4.0	8 90
83803		1.0 x 5.5	8 100
83804		1.2 x 6.5	10 125
83805		1.2 x 8.0	13 150
84001		PZ 1	8 80
84002		PZ 2	10 100





PRO

# VDE screwdrivers

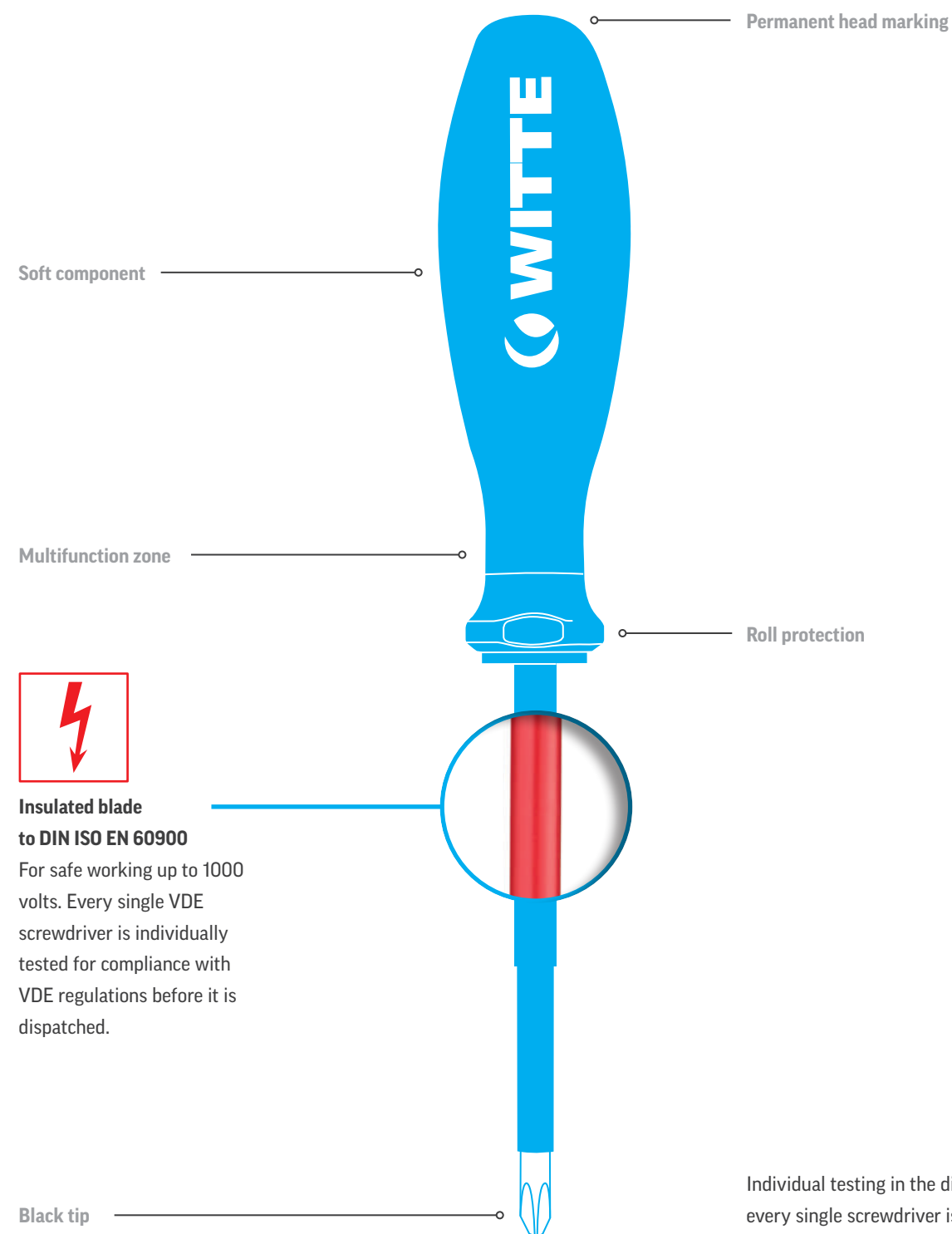
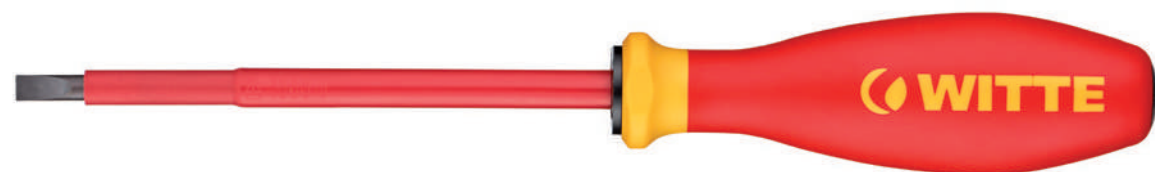

Individual testing in the dip tank: every single screwdriver is subjected to a high-voltage test in a water-filled dip tank. Even at 10,000 volts it must pass the dielectric strength test in order to receive VDE certification, which approves it for use on live components up to 1000 volts.

## 74050 slotted screwdrivers

to ISO 2380



ITEM NO.	mm	mm	mm	mm	ITEM NO.	mm	mm	mm	mm
74051	0.4 x 2.5	75	2.5	105 x 25	74055	1.0 x 5.5	125	5.5	115 x 34
74052	0.5 x 3.0	100	3.0	105 x 25	74056	1.2 x 6.5	150	6.5	115 x 34
74053	0.6 x 3.5	100	3.5	105 x 25	74057	1.2 x 8.0	175	8.0	125 x 37
74054	0.8 x 4.0	100	4.0	105 x 25	74058	1.6 x 10.0	200	10.0	125 x 37

## 74060 PH screwdrivers

tip to ISO 8764 for PHILLIPS recess screws

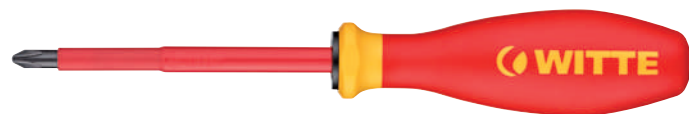

ITEM NO.	mm	mm	mm	mm	ITEM NO.	mm	mm	mm	mm
74061	PH 0	60	3.0	105 x 25	74064	PH 3	150	8.0	125 x 37
74062	PH 1	80	4.5	105 x 25	74065	PH 4	200	10.0	125 x 37
74063	PH 2	100	6.0	115 x 34					

## 74080 MODUL PH screwdrivers

for +/- screws in electrical installations

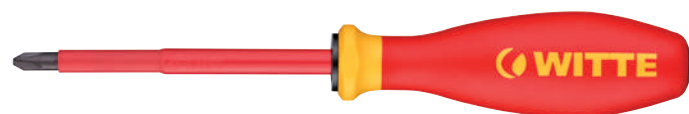

ITEM NO.	mm	mm	mm	mm	ITEM NO.	mm	mm	mm	mm
74081	PH 1 / MODUL	80	4.5	105 x 25	74082	PH 2 / MODUL	100	6.0	115 x 34

## 74070 PZ screwdrivers

tip to ISO 8764 for POZIDRIV screws



ITEM NO.	mm	mm	mm	mm	ITEM NO.	mm	mm	mm	mm
74071	PZ 0	60	3.0	105 x 25	74074	PZ 3	150	8.0	125 x 37
74072	PZ 1	80	4.5	105 x 25	74075	PZ 4	200	10.0	125 x 37
74073	PZ 2	100	6.0	115 x 34					

## 74090 MODUL PZ screwdrivers

for +/- screws in electrical installations

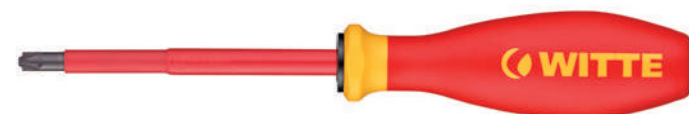

ITEM NO.	mm	mm	mm	mm	ITEM NO.	mm	mm	mm	mm
74091	PZ 1 / MODUL	80	4.5	105 x 25	74092	PZ 2 / MODUL	100	6.0	115 x 34

## 74080 TORX® screwdrivers



ITEM NO.	mm	mm	mm	mm	ITEM NO.	mm	mm	mm	mm
74083	T 8	60	3.0	105 x 25	74087	T 20	100	4.0	105 x 25
74084	T 9	60	3.0	105 x 25	74088	T 25	100	4.5	105 x 25
74085	T 10	60	3.0	105 x 25	74089	T 30	100	6.0	105 x 25
74086	T 15	75	3.5	105 x 25					

## 74180 nutdrivers



ITEM NO.	mm	mm	mm	mm	ITEM NO.	mm	mm	mm	mm
74181	6	125	5.0	115 x 34	74185	10	125	6.0	115 x 34
74182	7	125	6.0	115 x 34	74186	11	125	8.0	125 x 37
74183	8	125	6.0	115 x 34	74187	12	125	8.0	125 x 37
74184	9	125	6.0	115 x 34	74188	13	125	8.0	125 x 37

## Sets of screwdrivers

### 6-pcs. set

Order no. 670022

ITEM NO.	Drive	mm	mm
74051	●	0.4 x 2.5	75
74054	●	0.8 x 4.0	100
74055	●	1.0 x 5.5	125
74056	●	1.2 x 6.5	150
74062	⊕	PH 1	80
74063	⊕	PH 2	100

### 6-pcs. set

Order no. 670023

ITEM NO.	Drive	mm	mm
74051	●	0.4 x 2.5	75
74054	●	0.8 x 4.0	100
74055	●	1.0 x 5.5	125
74056	●	1.2 x 6.5	150
74072	⊕	PZ 1	80
74073	⊕	PZ 2	100

### 5-pcs. set

Order no. 670024

ITEM NO.	Drive	mm	mm
74051	●	0.4 x 2.5	75
74054	●	0.8 x 4.0	100
74055	●	1.0 x 5.5	125
74062	⊕	PH 1	80
74063	⊕	PH 2	100

### 5-pcs. set

Order no. 670025

ITEM NO.	Drive	mm	mm
74051	●	0.4 x 2.5	75
74054	●	0.8 x 4.0	100
74055	●	1.0 x 5.5	125
74072	⊕	PZ 1	80
74073	⊕	PZ 2	100





PRO

VDE slim

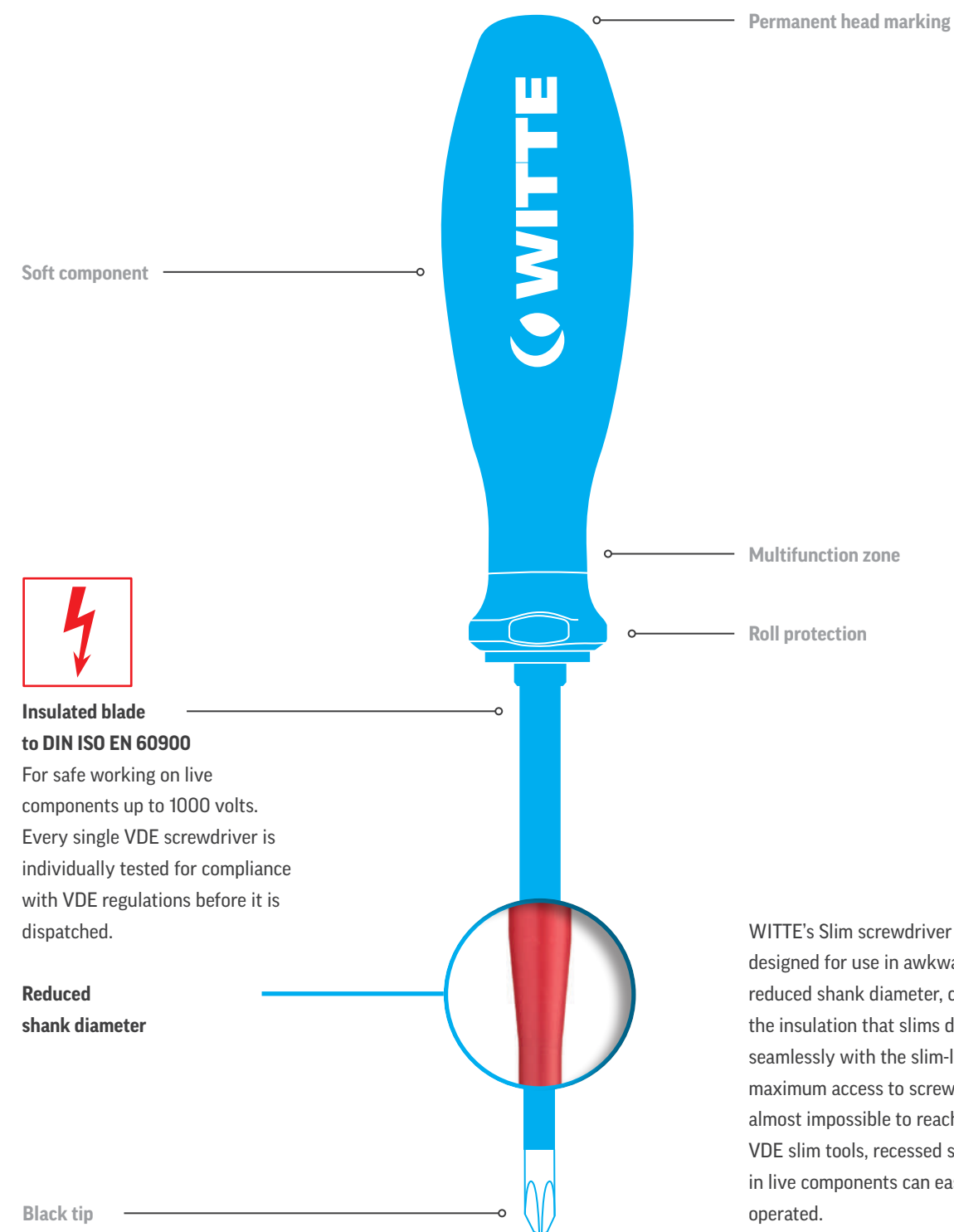







WITTE's Slim screwdriver variants are designed for use in awkward spots. The reduced shank diameter, coupled with the insulation that slims down to blend seamlessly with the slim-line tip, ensures maximum access to screws that are often almost impossible to reach. By using the PRO VDE slim tools, recessed screws and springs in live components can easily and safely be operated.

The rounded triangular form guarantees excellent force transmission thanks to the easy-to-grip soft zone and the roll protection section in the quality you expect of WITTE.

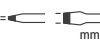
## 76010 screwdrivers

to ISO 2380





ITEM NO.	 mm	 mm	 mm	ITEM NO.	 mm	 mm	 mm	 mm
76012	0.5 x 3.0	100	3.0	76015	1.0 x 5.5	125	5.5	115 x 34
76014	0.8 x 4.0	100	4.0	76016	1.2 x 6.5	150	6.5	115 x 34
76017	0.8 x 4.5	175	4.5					

## 76020 PH screwdrivers

tip to ISO 8764 for PHILLIPS® recess screwdrivers





ITEM NO.	 mm	 mm	 mm
76022	PH 1	80	4.5
76023	PH 2	100	6.0

## 76020 MODUL PH screwdrivers

for +/- screws in electrical installations





ITEM NO.	 mm	 mm	 mm
76025	PH 1 / MODUL	80	4.5
76026	PH 2 / MODUL	100	6.0

## 76030 PZ screwdrivers

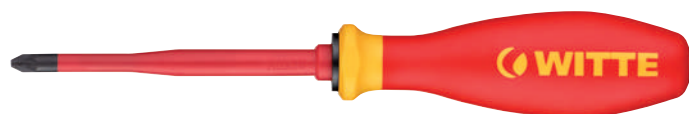
tip to ISO 8764 for POZIDRIV® screws





ITEM NO.	 mm	 mm	 mm
76032	PZ 1	80	4.5
76033	PZ 2	100	6.0

## 76030 MODUL PZ screwdrivers

for +/- screws in electrical installations









ITEM NO.	 mm	 mm	 mm
76035	PZ 1 / MODUL	80	4.5
76036	PZ 2 / MODUL	100	6.0

## Sets of screwdrivers







### 5-pcs. set

Order no. 670080

ITEM NO.	Drive	mm	 mm
76012		0.5 x 3.0	100
76014		0.8 x 4.0	100
76015		1.0 x 5.5	125
76022		PH 1	80
76023		PH 2	100







### 5-pcs. set

Order no. 670081

ITEM NO.	Drive	mm	 mm
76012		0.5 x 3.0	100
76014		0.8 x 4.0	100
76015		1.0 x 5.5	125
76032		PZ 1	80
76033		PZ 2	100







### 6-pcs. set

Order no. 670082

ITEM NO.	Drive	mm	 mm
76012		0.5 x 3.0	100
76014		0.8 x 4.0	100
76015		1.0 x 5.5	125
76016		1.2 x 6.5	150
76022		PH 1	80
76023		PH 2	100

### 6-pcs. set

Order no. 670083

ITEM NO.	Drive	mm	 mm
76012		0.5 x 3.0	100
76014		0.8 x 4.0	100
76015		1.0 x 5.5	125
76016		1.2 x 6.5	150
76032		PZ 1	80
76033		PZ 2	100

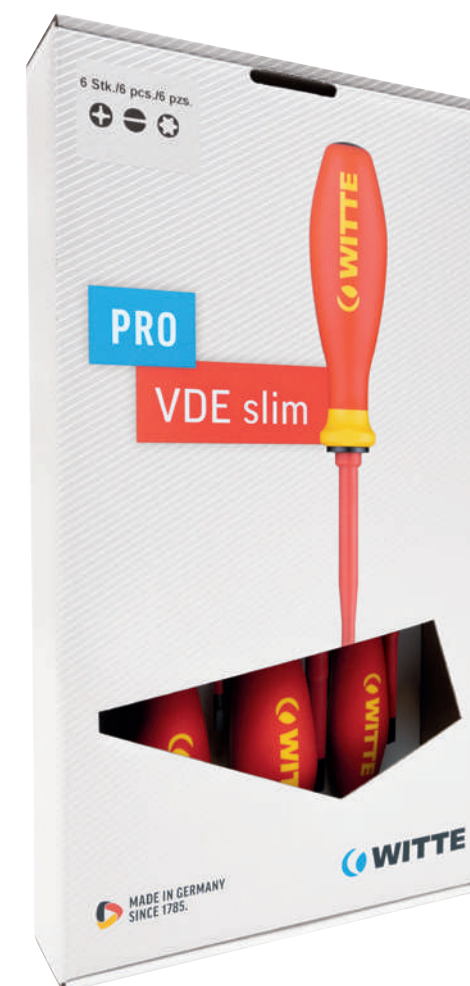



PRO

BITDRIVE®



**Integrated bit storage**

The magnetic mechanism holds the bits in place to make it easier for you to pick the one you need.

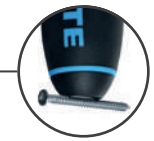

**Convenient magnetic holder**

For attaching small metallic components.



One-hand release mechanism

Soft component

Roll protection

Quick-change bit holder

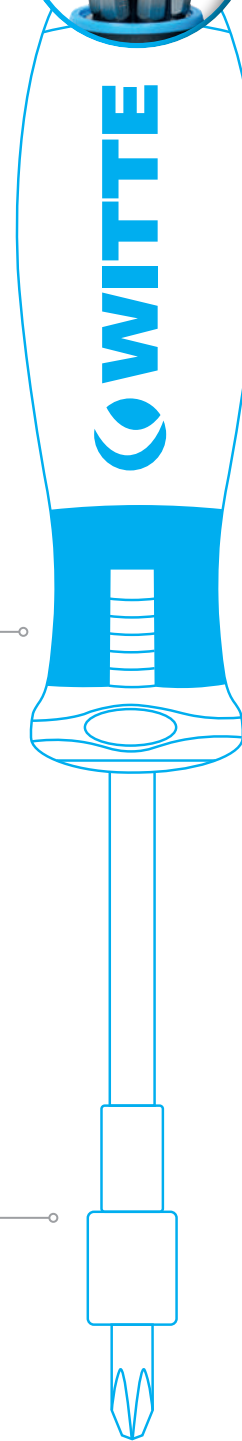

With the WITTE PRO BITDRIVE® you really have everything at your fingertips. Apart from the ergonomically designed grip that allows you to transmit even higher torques, the new PRO BITDRIVE® incorporates a magazine containing six bits in the handle end. The whole construction is, of course, in the proven WITTE PRO design. Ergonomic handling can be this convenient.



**One-hand release mechanism**  
Easy opening of the bit storage with only one finger.



**Fast access**  
The magnetic mechanism holds the bits in a petal-like arrangement to make it easier for you to pick the one you need.



**Convenient magnetic holder**  
For attaching small metallic components.



**Simple replacement**  
The magnetic mechanism holds the bits in place to make it easier for you to replace the one you've used.

**468023 PRO BITDRIVE® screwdriver**

Screwdriver with 6 bits, individually packed in a transparent box with a hanging hole



Qty		ITEM NO.	Drive	mm	1/4" drive
1	+	27020	PH 1	25	C6.3
1	+	27021	PH 2	25	C6.3
1	+	27022	PH 3	25	C6.3
1	+	27045	PZ1	25	C6.3
1	+	27046	PZ2	25	C6.3
1	+	27047	PZ3	25	C6.3

**468024 PRO BITDRIVE® screwdriver**

Screwdriver with 6 bits, individually packed in a transparent box with a hanging hole



Qty		ITEM NO.	Drive	mm	1/4" drive
1	⊗	29503	T 10	25	C6.3
1	⊗	29504	T 15	25	C6.3
1	⊗	29505	T 20	25	C6.3
1	⊗	29506	T 25	25	C6.3
1	⊗	29508	T 30	25	C6.3
1	⊗	29509	T 40	25	C6.3



**PRO**

# BITDRIVE® RATCHET



### Integrated bit storage

The magnetic mechanism holds the bits in place to make it easier for you to pick the one you need.

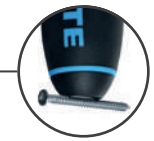

### Convenient magnetic holder

For attaching small metallic components.



One-hand release mechanism

Roll protection

Soft component

High-quality metal ratchet

Quick-change bit holder

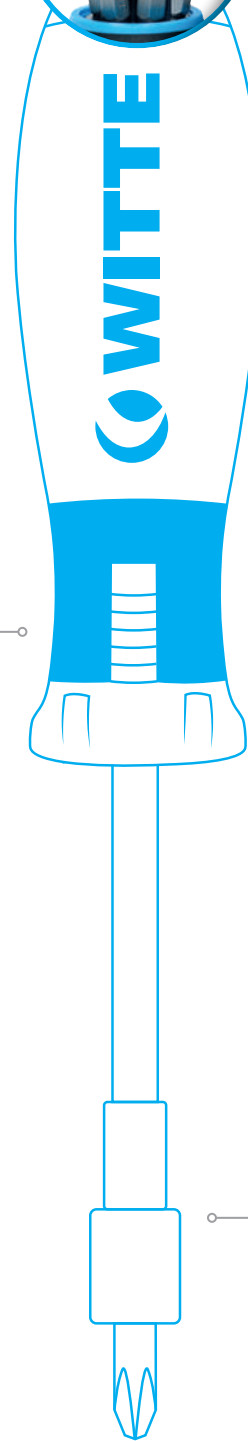

The BITDRIVE® RATCHET has all the benefits of the PRO BITDRIVE® – supplemented with the handy ratchet function. For even more efficient tightening and loosening.

## BITDRIVE® RATCHET



**One-hand release mechanism**  
Easy opening of the bit storage with only one finger.



**Fast access**  
The magnetic mechanism holds the bits in a petal-like arrangement to make it easier for you to pick the one you need.



**Convenient magnetic holder**  
For attaching small metallic components.



**Simple replacement**  
The magnetic mechanism holds the bits in place to make it easier for you to replace the one you've used.



**High-quality metal ratchet**  
With locked, anticlockwise and clockwise functions. For even more efficient tightening and loosening.

## 468021 PRO BITDRIVE® RATCHET screwdriver

Screwdriver with 6 bits and a metal ratchet, individually packed in a transparent box with a hanging hole



Qty		ITEM NO.	Drive	mm	1/4" drive
1	+	27020	PH 1	25	C6.3
1	+	27021	PH 2	25	C6.3
1	+	27022	PH 3	25	C6.3
1	+	27045	PZ1	25	C6.3
1	+	27046	PZ2	25	C6.3
1	+	27047	PZ3	25	C6.3

## 468022 PRO BITDRIVE® RATCHET screwdriver

Screwdriver with 6 bits and a metal ratchet, individually packed in a transparent box with a hanging hole



Qty		ITEM NO.	Drive	mm	1/4" drive
1	*	29503	T 10	25	C6.3
1	*	29504	T 15	25	C6.3
1	*	29505	T 20	25	C6.3
1	*	29506	T 25	25	C6.3
1	*	29508	T 30	25	C6.3
1	*	29509	T 40	25	C6.3



PRO

# BITDRIVE® TORQUE

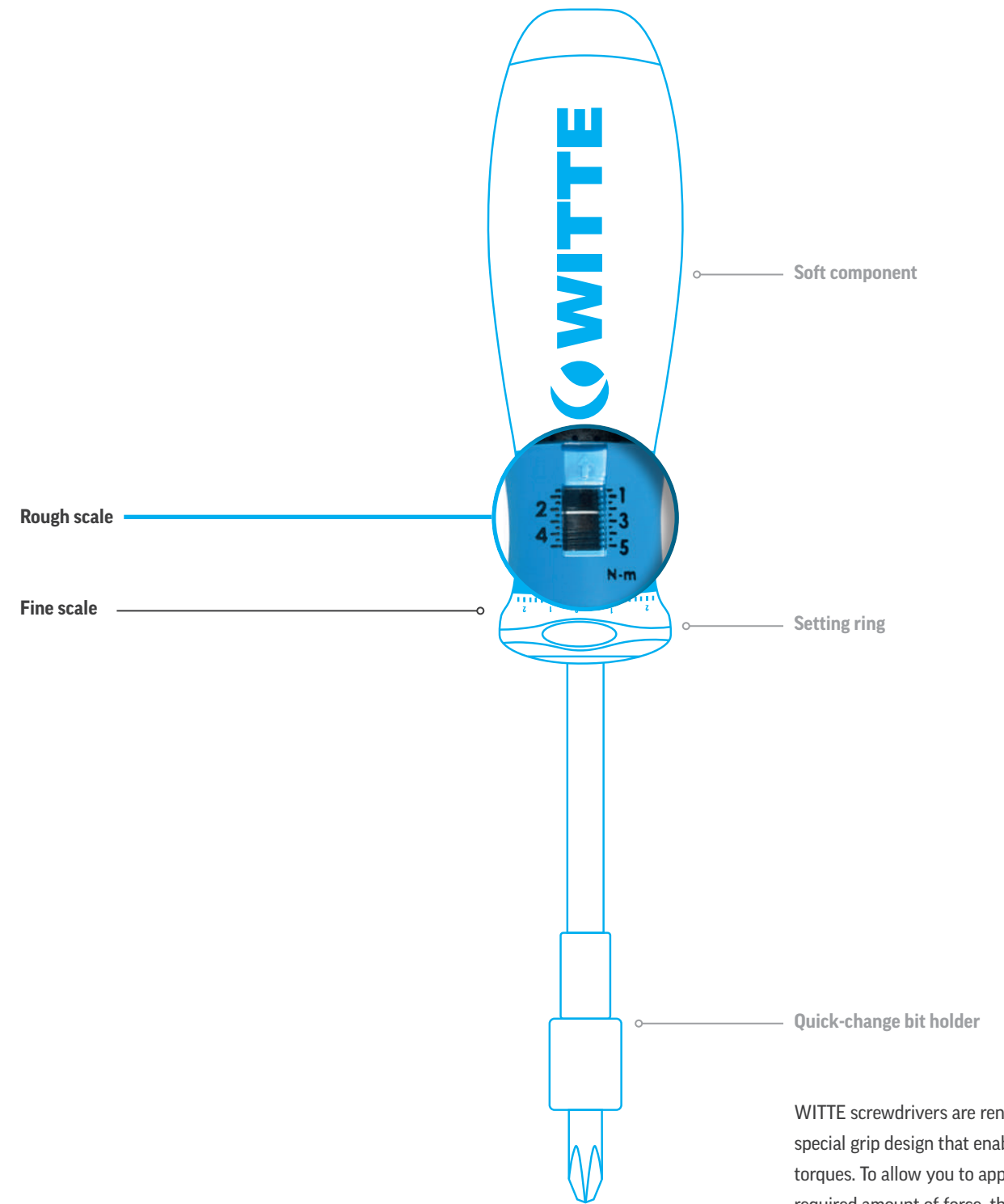

WITTE screwdrivers are renowned for their special grip design that enables maximum torques. To allow you to apply exactly the required amount of force, there is now, with immediate effect, the PRO BITDRIVE® TORQUE with its convenient fast-action torque setting. The quick-change bit holder provides additional security.

## BITDRIVE® TORQUE



### Easily readable scale

Rough and fine scale for accurate setting of the required target torque.



### Convenient setting ring

Fast, easy rotary setting of torques from 1.0 – 5.0 Nm.

## 468014 PRO BITDRIVE® TORQUE screwdrivers

Torque screwdrivers for torques from 1.0 - 5.0 Nm, individually packed in a transparent box with a hanging hole





PRO

# BITDRIVE® TORQUE VDE

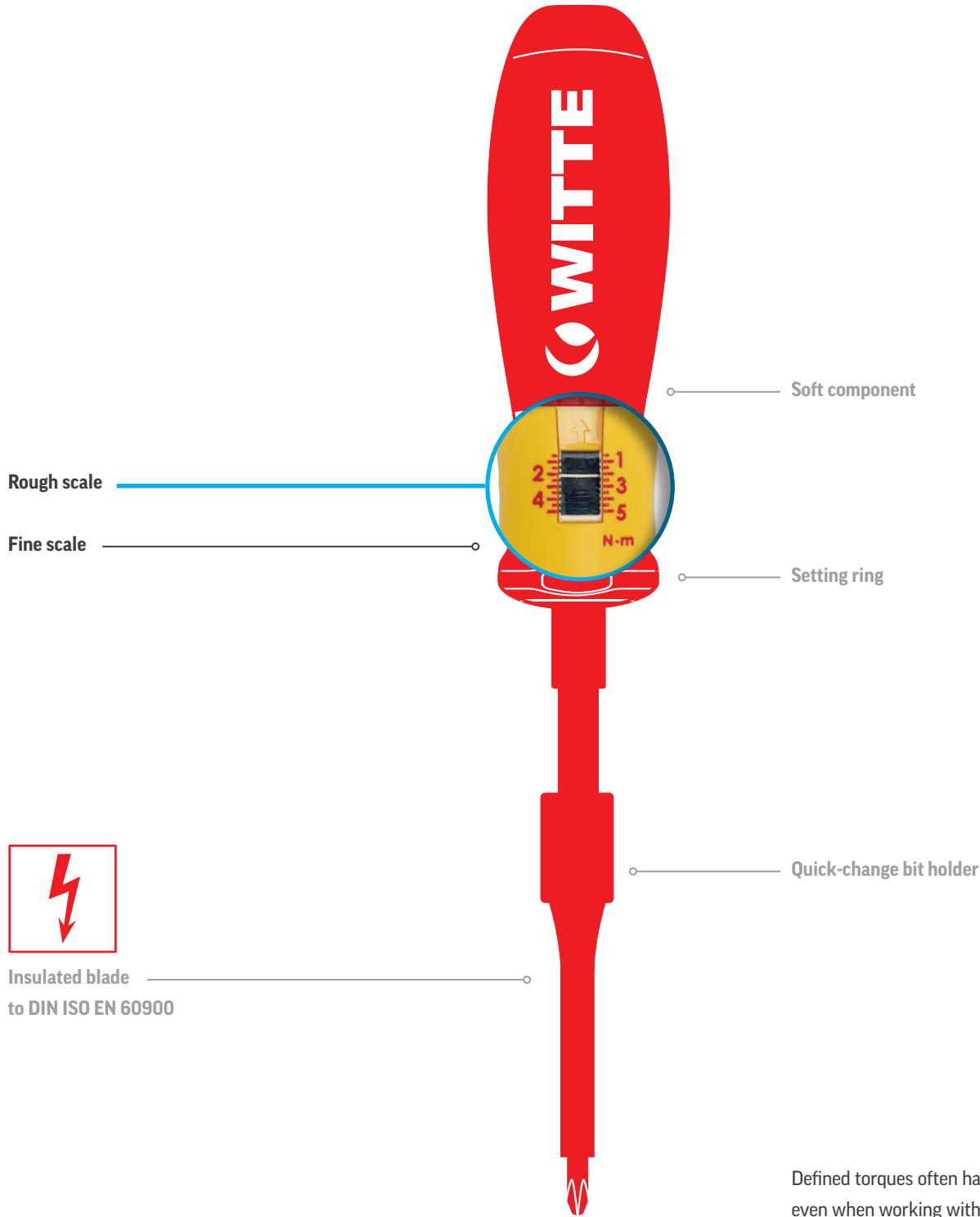
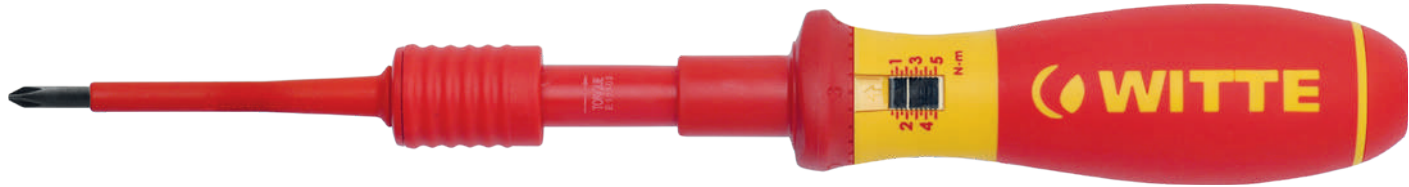

Defined torques often have to be achieved even when working with live components. This is where the BITDRIVE® TORQUE VDE comes into play. As an added bonus: replaceable blades are tested to DIN ISO EN 60900.

## BITDRIVE® TORQUE VDE



**Easily readable scale**  
Rough and fine scale for accurate setting of the required target torque.



**Convenient setting ring**  
Fast, easy rotary setting of torques from 1.0 – 5.0 Nm.



**Safe-change mount**  
For mounting and changing insulated blades. Tested to DIN EN IEC 60900.

## 468015 PRO BITDRIVE® TORQUE VDE screwdrivers

VDE torque screwdrivers for torques from 1.0 - 5.0 Nm, individually packed in a transparent box with a hanging hole



**incl. PH 2 interchangeable blade**



Drive	mm	mm
+	PH 2	100

## 301272 WITTE BITDRIVE® TORQUE VDE 1 SET

PRO BITDRIVE® TORQUE incl. 5 interchangeable blades in a zip-up wallet



Drive	mm	mm
●	0.5 x 0.3	60
●	0.8 x 4.0	80
●	1.0 x 5.5	80
+	PH 1	80
+	PH 2	100



## 301282 WITTE BITDRIVE® TORQUE VDE 2 SET

PRO BITDRIVE® TORQUE incl. 5 interchangeable blades in a roll-up wallet



Drive	mm	mm
●	0.5 x 0.3	60
●	0.8 x 4.0	80
●	1.0 x 5.5	80
+	PH 1	80
+	PH 2	100



## 468010 Interchangeable blades for BITDRIVE® TORQUE VDE

single, packed in polybag



ITEM NO.	Drive	mm	mm
468016	●	0.5 x 0.3	60
468017	●	0.8 x 4.0	80
468018	●	1.0 x 5.5	80
468019	+	PH 1	80
468020	+	PH 2	100





**PRO**

# ESD screwdrivers

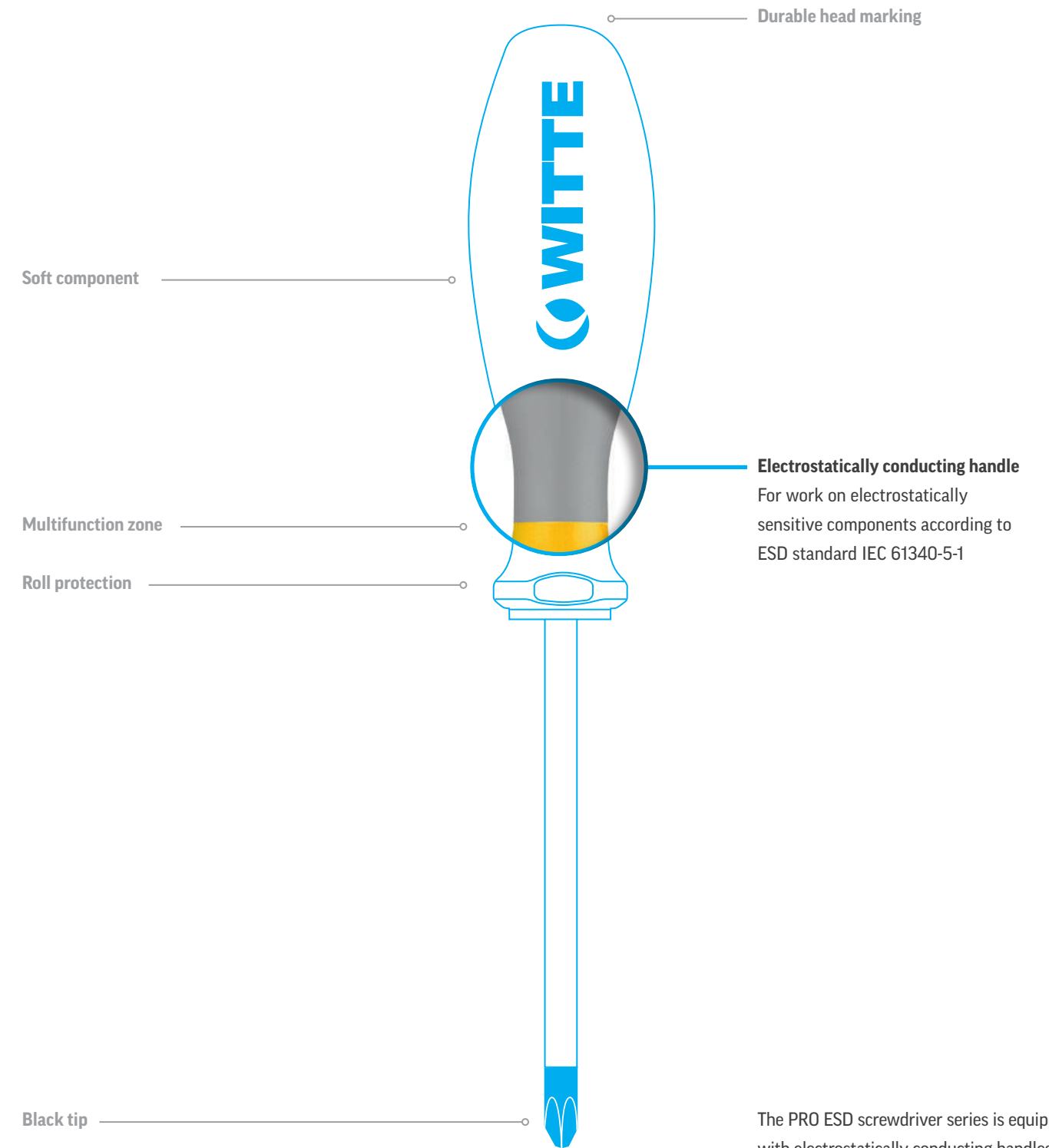
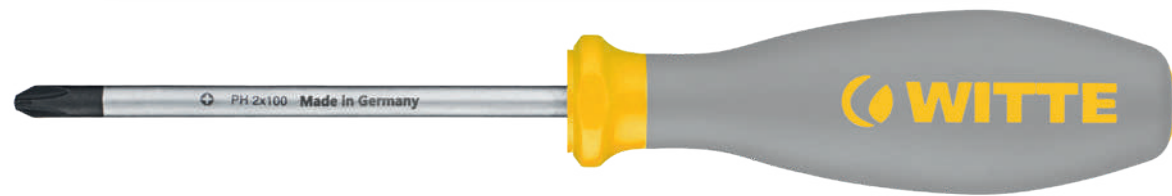

The PRO ESD screwdriver series is equipped with electrostatically conducting handles. This enables work to be carried out on electrostatically sensitive components with a working resistance of  $10^6 - 10^9$  ohms. The handles are electrostatically conducting to DIN EN 61340-5-1.

## 85540 slotted keystone/engineer's screwdrivers

to DIN 5264 and ISO 2380



ITEM NO.	mm	mm		shank	mm
85541	0.5 x 3.0	75	3.0	105 x 25	105 x 25
85543	0.8 x 4.0	125	4.0	105 x 25	115 x 34
85544	1.0 x 5.5	150	5.5	115 x 34	115 x 34

## 94240 PH screwdrivers

tip to ISO 8764 for PHILLIPS recess screws



ITEM NO.		mm	mm	mm
94241	PH 0	60	3.0	105 x 25
94242	PH 1	80	4.5	105 x 25
94243	PH 2	100	6.0	115 x 34





**PRO**

voltage testers

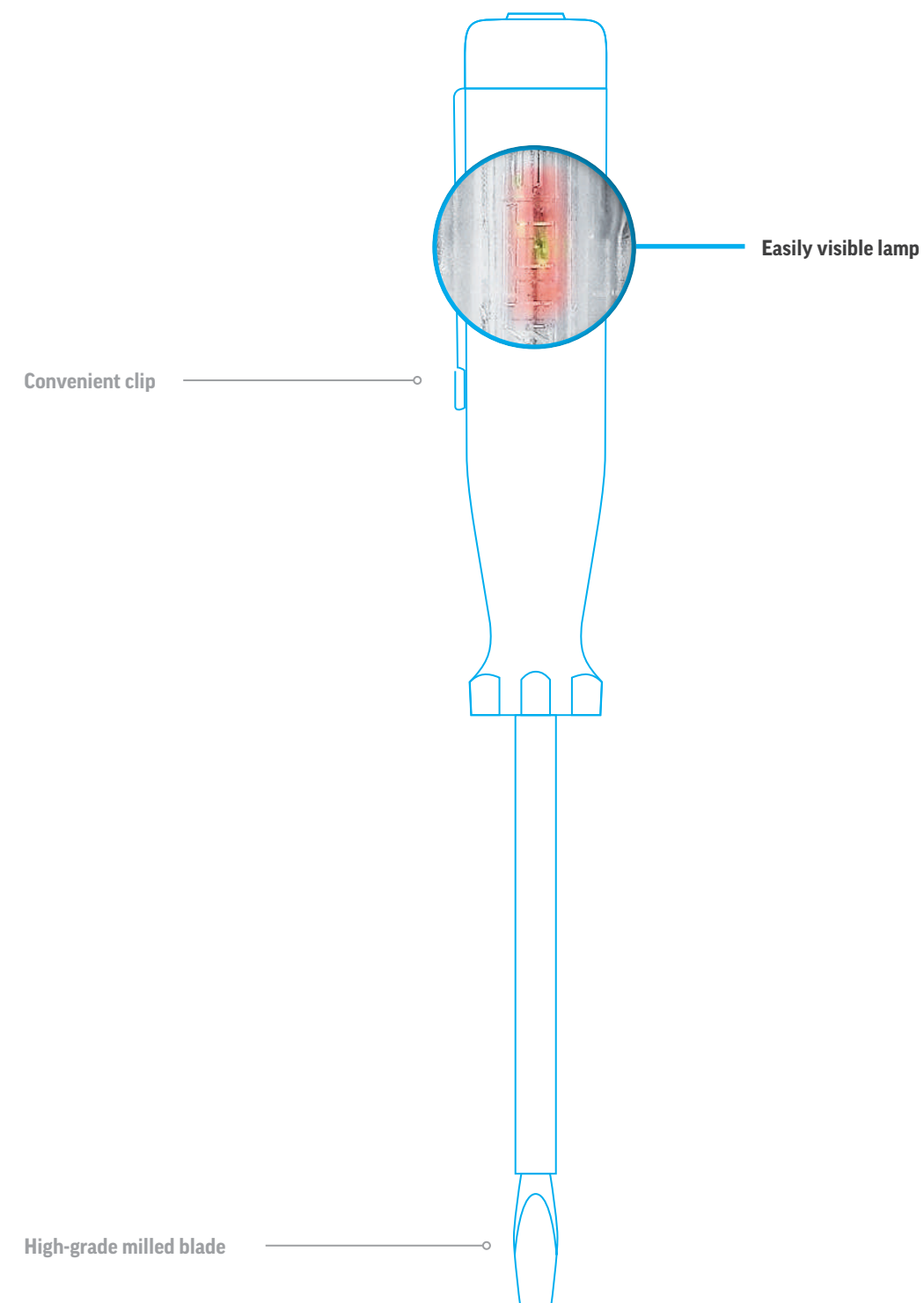





WITTE PRO voltage testers - check reliably and safely for the presence of AC currents up to 250 volts.



### 24083 voltage tester with metal clip

Tested to VDE 0680 Part 6







ITEM NO.	 mm	 mm	 mm	 mm
24083	3.0	65	75 x 15	140



### 24072 voltage tester

Tested to VDE 0680 Part 6







ITEM NO.	 mm	 mm	 mm	 mm
24072	3.5	100	85 x 17	185



### 24856 Euro voltage tester

Tested to VDE 0680 Part 6







ITEM NO.	 mm	 mm	 mm	 mm
24856	3.0	60	90 x 20	150



### 24857 Euro voltage tester

Tested to VDE 0680 Part 6



ITEM NO.	 mm	 mm	 mm	 mm
24857	3.5	100	90 x 20	190

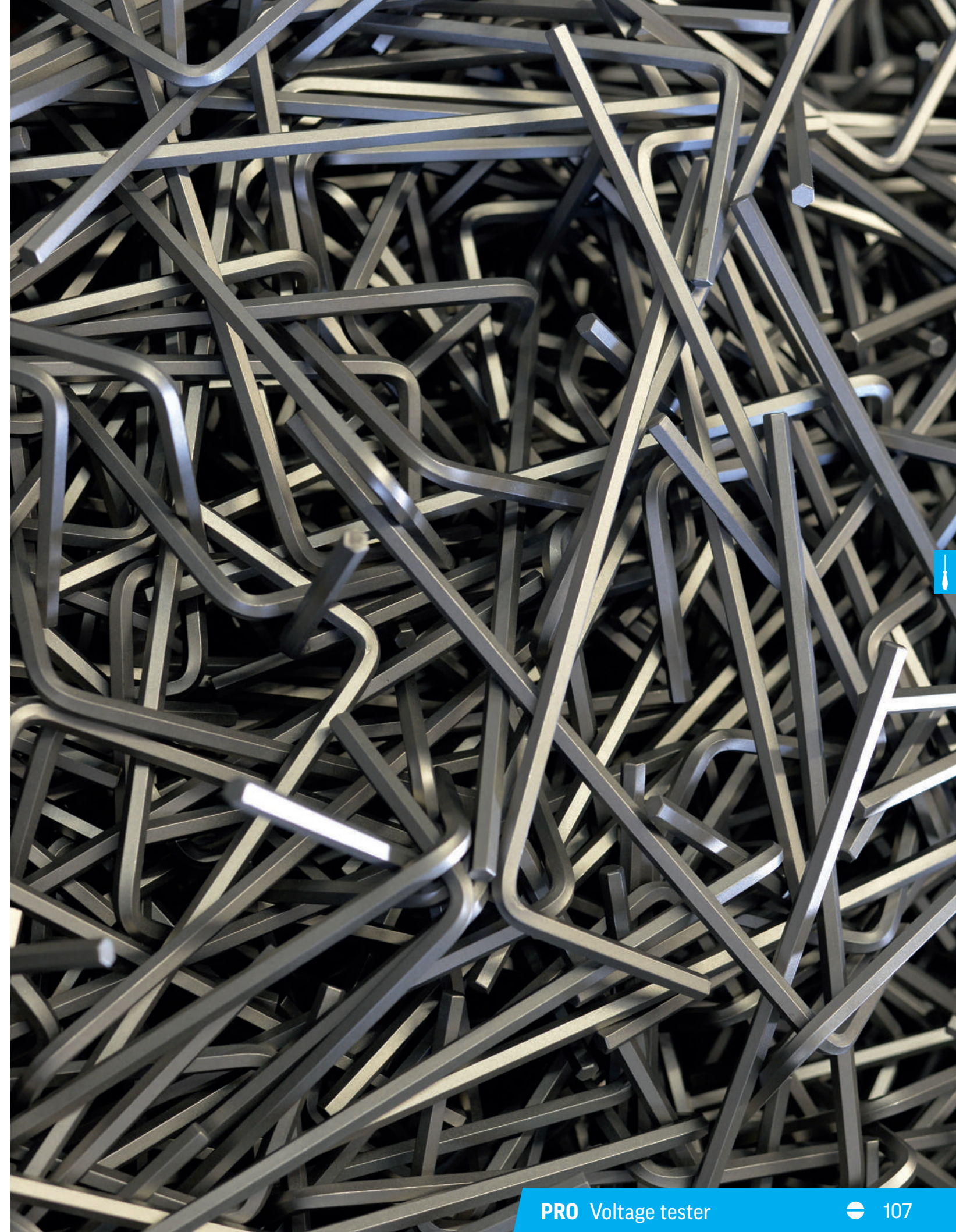



**PRO**  
Nature



**Leather cap**  
Absorbs impacts and protects against splinters

**Hard-wood handle**  
Made of durable beech-wood

**Bolster**  
For added torque

**Full-length blade**  
Forged from a single piece.  
Provides additional safety when tapping with a hammer

**Black tip**

Screwdrivers with wooden handles have a long tradition. Even today, they are still the preferred choice among those that appreciate tried-and-tested workmanship and like working with natural materials.

## 96500 slotted keystone/engineer's screwdrivers

Blade high-gloss chrome-plated with black tip



ITEM NO.		mm		mm	ITEM NO.		mm		mm	ITEM NO.		mm		mm
96501	0.6 x 3.5	75	6	4.5	96505	1.2 x 9.0	150	13	8	96509	2.5 x 13.0	250	16	11
96502	0.7 x 4.5	90	6	4.5	96506	1.6 x 10.0	175	13	9	96510	2.0 x 12.0	200	16	9
96503	0.8 x 5.5	100	8	5.5	96507	2.0 x 12.0	200	16	9	96511	2.5 x 13.0	250	16	11
96504	1.0 x 7.0	125	10	7.0	96508	2.5 x 13.0	250	16	11	96512	2.5 x 13.0	250	16	11

## 96600 PH screwdrivers

to ISO 8764 for PHILLIPS recess screws,  
blade high-gloss chrome-plated with black tip



ITEM NO.		mm		mm	ITEM NO.		mm		mm
96601	PH 1	85	6	4.5	96605	PH 4	200	16	10.0
96602	PH 2	100	10	6.0	96606	PH 4	200	16	10.0
96603	PH 3	150	13	8.0	96607	PH 4	200	16	10.0
96604	PH 4	200	16	10.0	96608	PH 4	200	16	10.0

## 96700 PZ screwdrivers

to ISO 8764 for POZIDRIV screws,  
blade high-gloss chrome-plated with black tip



ITEM NO.		mm		mm	ITEM NO.		mm		mm
96701	PZ 1	85	6	4.5	96705	PZ 4	200	16	10.0
96702	PZ 2	100	10	6.0	96706	PZ 4	200	16	10.0
96703	PZ 3	150	13	8.0	96707	PZ 4	200	16	10.0
96704	PZ 4	200	16	10.0	96708	PZ 4	200	16	10.0

## Sets of screwdrivers

### 6-pcs. set

Order no. 620326

ITEM NO.	Drive	mm		mm
96501		0.6 x 3.5	6	75
96502		0.7 x 4.5	6	90
96503		0.8 x 5.5	8	100
96504		1.0 x 7.0	10	125
96601		PH 1	6	85
96602		PH 2	10	100

### 6-pcs. set

Order no. 620327

ITEM NO.	Drive	mm		mm
96501		0.6 x 3.5	6	75
96502		0.7 x 4.5	6	90
96503		0.8 x 5.5	8	100
96504		1.0 x 7.0	10	125
96701		PZ 1	6	85
96702		PZ 2	10	100

### 6-pcs. set

Order no. 620302

ITEM NO.	Drive	mm		mm
96502		0.7 x 4.5	6	90
96503		0.8 x 5.5	8	100
96504		1.0 x 7.0	10	125
96505		1.2 x 9.0	13	150
96601		PH 1	6	85
96602		PH 2	10	100

### 6-pcs. set

Order no. 620400

ITEM NO.	Drive	mm		mm
96502		0.7 x 4.5	6	90
96503		0.8 x 5.5	8	100
96504		1.0 x 7.0	10	125
96505		1.2 x 9.0	13	150
96701		PZ 1	6	85
96702		PZ 2	10	100

### 5-pcs. set

Order no. 620306

ITEM NO.	Drive	mm		mm
96502		0.7 x 4.5	6	90
96503		0.8 x 5.5	8	100
96504		1.0 x 7.0	10	125
96601		PH 1	6	85
96602		PH 2	10	100

### 5-pcs. set

Order no. 620303

ITEM NO.	Drive	mm		mm
96502		0.7 x 4.5	6	90
96503		0.8 x 5.5	8	100
96504		1.0 x 7.0	10	125
96701		PZ 1	6	85
96702		PZ 2	10	100



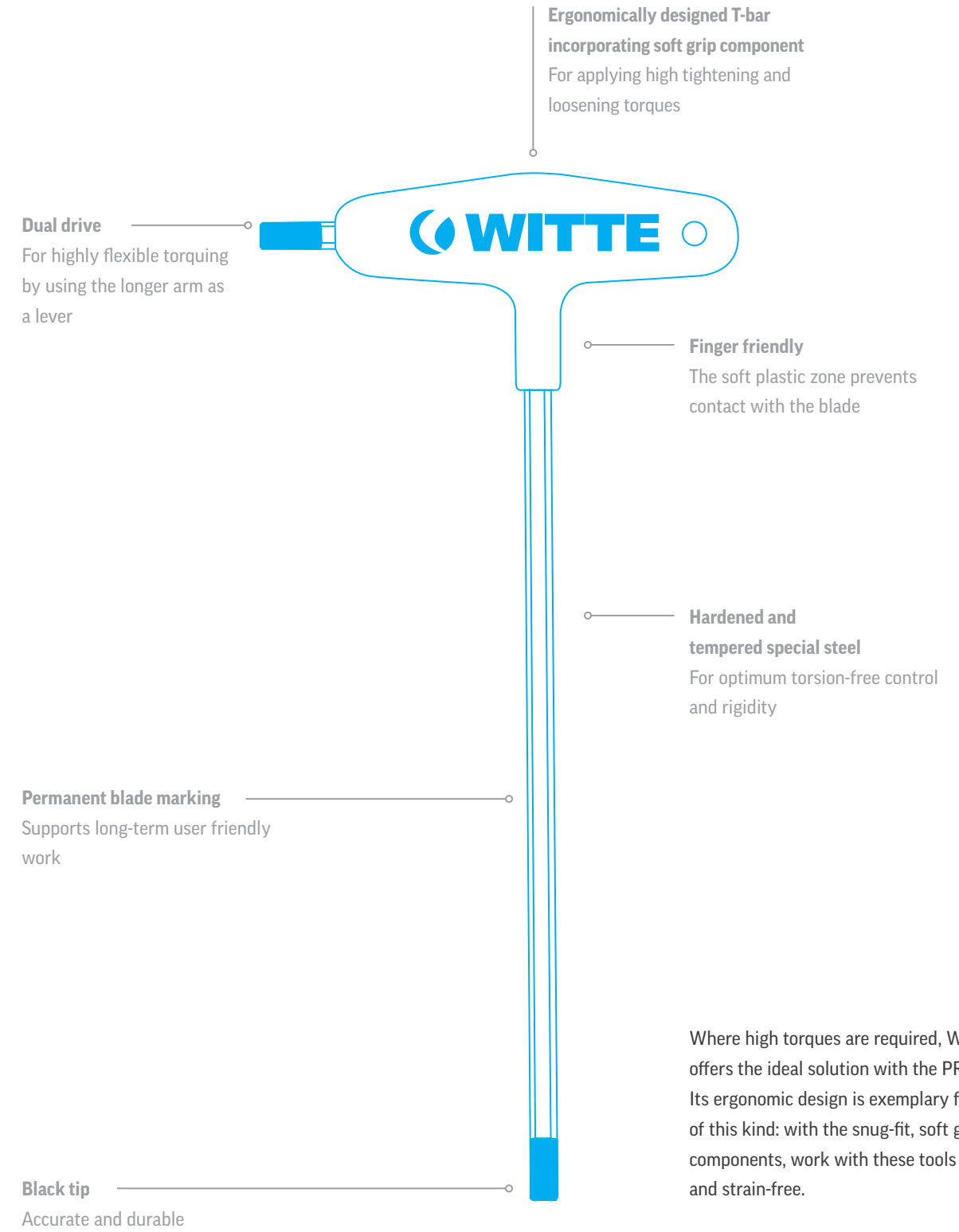



Where high torques are required, WITTE offers the ideal solution with the PRO T-bar. Its ergonomic design is exemplary for tools of this kind: with the snug-fit, soft grip components, work with these tools is easier and strain-free.

This design also does away with edges, which aids cramp-free grip and simplifies changing your hand position. Convenient: to magnify the torque acting on the screw considerably, use the shorter shank for the screw and the longer one as the lever.

## 81600 internal hex screwdrivers with a single drive





ITEM NO.	Ø	 mm	 mm
81602	2.0	100	95
81625	2.5	100	95
81603	3.0	150	95
81604	4.0	150	95
81605	5.0	200	95
81606	6.0	200	95
81608	8.0	200	120
81610	10.0	200	120



## 81100 internal hex screwdrivers with dual drive



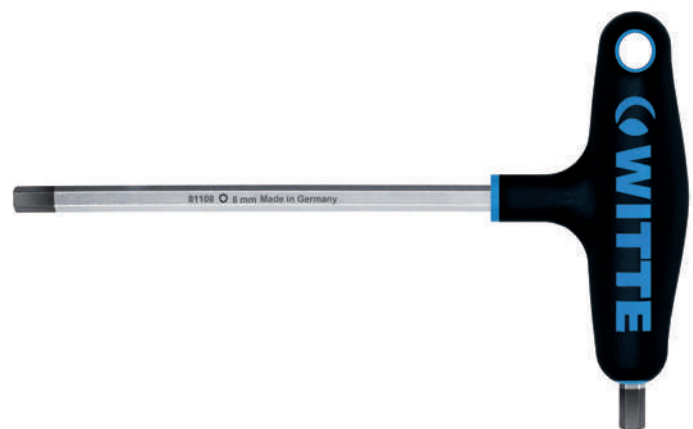

ITEM NO.	Ø	 mm	 mm	 mm
81102	2.0	100	10	95
81125	2.5	100	10	95
81103	3.0	150	15	95
81104	4.0	150	15	95
81105	5.0	200	15	95
81106	6.0	200	15	95
81108	8.0	200	20	120
81110	10.0	200	25	120



## 81700 TORX® screwdrivers with a single drive







ITEM NO.	Ø	 mm	 mm	
81709	T 9	100	95	M 3.0
81710	T 10	100	95	M 3.0
81715	T 15	100	95	M 3.5
81720	T 20	100	95	M 4.0
81725	T 25	110	95	M 5.0
81727	T 27	110	95	M 5.0
81730	T 30	130	95	M 6.0
81740	T 40	130	120	M 8.0
81750	T 50	130	120	M 10.0



## 81400 TORX® screwdrivers with dual drive



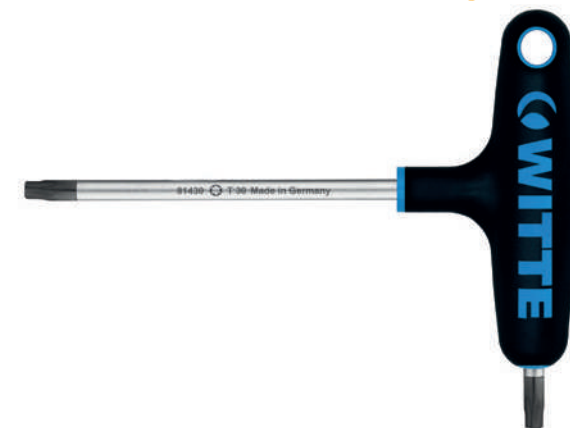

ITEM NO.		 mm	 mm	 mm	
81409	T 9	100	15	95	M 3.0
81410	T 10	100	15	95	M 3.0
81415	T 15	100	15	95	M 3.5
81420	T 20	100	15	95	M 4.0
81425	T 25	110	15	95	M 5.0
81427	T 27	110	15	95	M 5.0
81430	T 30	130	15	95	M 6.0
81440	T 40	130	20	120	M 8.0
81450	T 50	130	25	120	M 10.0



## 81200 nutdrivers



ITEM NO.		 mm	 mm
81204	4.0	200	95
81245	4.5	200	95
81205	5.0	200	95
81255	5.5	200	95
81206	6.0	200	95
81207	7.0	200	120
81208	8.0	200	120
81209	9.0	200	120
81210	10.0	200	120
81211	11.0	200	120
81212	12.0	200	120
81213	13.0	200	120
81217	17.0	200	120



## 82620 bitholder with 150 mm blade and permanent magnet



ITEM NO.		 mm	 mm
82620	1/4"	150	95





PRO

WITTRON®



Rotatable cap with ergonomic finger recess  
For one-handed rotation



Soft component  
For optimum grip



Spin zone  
Slim and manageable -  
for finger-tip control



Special steel  
Hardened and tempered,  
made in Germany



Black tip  
More accuracy and durability







Accurate work needs precision tools. In particular when carrying out precision mechanical tasks and in electronics applications there is a need for finger-tip control in confined spaces and very carefully gauged application of force. This is where the PRO WITTRON® screwdriver series comes into its own.

These tools feature geometries developed specifically for their field of application. A large finger recess, even slimmer spin zones and large-sized soft components enable the worker to use finger-tip control.

## 89710 slotted screwdrivers







ITEM NO.		mm		mm	ITEM NO.		mm		mm
89711	0.16 x 0.8	40	2.5	100	89718	0.50 x 3.0	75	3.0	100
89712	0.18 x 1.0	40	2.5	100	89719	0.50 x 3.0	150	3.0	100
89713	0.25 x 1.2	40	2.5	100	89720	0.60 x 3.5	100	3.5	100
89714	0.30 x 1.5	40	2.5	100	89721	0.60 x 3.5	150	3.5	100
89715	0.30 x 1.8	60	2.5	100	89722	0.80 x 4.0	100	4.0	100
89716	0.40 x 2.0	60	2.5	100	89723	0.80 x 4.0	150	4.0	100
89717	0.40 x 2.5	75	2.5	100	89724	0.80 x 4.0	200	4.0	100

## 89730 PH screwdrivers

for PHILLIPS recess screws





ITEM NO.		mm		mm	ITEM NO.		mm		mm
89731	PH 000	40	2.0	100	89734	PH 1	80	4.5	100
89732	PH 00	40	2.5	100	89735	PH 1	150	4.5	100
89733	PH 0	60	3.0	100					

## 89740 PZ screwdrivers





for POZIDRIV screws



ITEM NO.		mm		mm
89741	PZ 0	60	3	100
89742	PZ 1	80	4.5	100





## 89750 TORX® screwdrivers



ITEM NO.		mm		mm	ITEM NO.		mm		mm
89751	T 5	50	2.5	100	89755	T 9	60	3.0	100
89752	T 6	50	2.5	100	89756	T 10	80	3.0	100
89753	T 7	50	2.5	100	89757	T 15	80	3.5	100
89754	T 8	60	3.0	100	89758	T 20	100	4.0	100





## 89760 hex screwdrivers



ITEM NO.		mm		mm	ITEM NO.		mm		mm
89761	0.7	40	100	89765	2.0	50	100		
89762	0.9	40	100	89766	2.5	60	100		
89763	1.3	40	100	89767	3.0	60	100		
89764	1.5	50	100						



## 89770 ball-end hex screwdrivers



ITEM NO.		mm		mm	ITEM NO.		mm		mm
89771	1.5	50	2.5	100					
89772	2.0	50	3.0	100					
89773	2.5	60	3.0	100					
89774	3.0	60	3.5	100					

## 89780 nutdrivers



ITEM NO.		mm		mm
89781	1.5	60	100	
89782	1.8	60	100	
89783	2.0	60	100	
89784	2.5	60	100	
89785	3.0	60	100	
89786	3.2	60	100	
89787	3.5	60	100	
89788	4.0	60	100	
89789	4.5	60	100	
89790	5.0	60	100	
89791	5.5	60	100	
89792	6.0	60	100	

## 89793 bitholder

with 60 mm blade and permanent magnet



ITEM NO.		mm		mm
89793	1/4"	60	100	



## Sets of screwdrivers

in high-impact plastic cases

### 7-pcs. set

Order no. 89321

ITEM NO.	Drive	mm	mm
89712	●	0.18 x 1.0	40
89713	●●	0.25 x 1.2	40
89714	●●●	0.30 x 1.5	40
89715	●●●●	0.30 x 1.8	60
89716	●●●●●	0.40 x 2.0	60
89717	●●●●●●	0.40 x 2.5	75
89718	●●●●●●●	0.50 x 3.0	75

### 7-pcs. set

Order no. 89322

ITEM NO.	Drive	mm	mm
89714	●	0.30 x 1.5	40
89716	●●	0.40 x 2.0	60
89717	●●●	0.40 x 2.5	75
89718	●●●●	0.50 x 3.0	75
89732	⊕	PH 00	40
89733	⊕	PH 0	60
89734	⊕	PH 1	80

### 7-pcs. set

Order no. 89323

ITEM NO.	Drive	mm	mm
89751	⊕	T 5	50
89752	⊕	T 6	50
89753	⊕	T 7	50
89754	⊕	T 8	60
89755	⊕	T 9	60
89756	⊕	T 10	80
89757	⊕	T 15	80

### 7-pcs. set

Order no. 89324

ITEM NO.	Drive	mm	mm
89761	○	0.7	40
89762	○○	0.9	40
89763	○○○	1.3	40
89764	○○○○	1.5	50
89765	○○○○○	2.0	50
89766	○○○○○●	2.5	60
89767	○○○○○●●	3.0	60

### 7-pcs. set

Order no. 89325

ITEM NO.	Drive	mm	mm
89784	●	2.5	60
89785	●●	3.0	60
89786	●●●	3.2	60
89787	●●●●	3.5	60
89788	●●●●●	4.0	60
89790	●●●●●●	5.0	60
89791	●●●●●●●	5.5	60

### 7-pcs. set

Order no. 89327

ITEM NO.	Drive	mm	mm
89714	●	0.30 x 1.5	40
89733	⊕	PH 0	60
89764	○	1.5	50
89765	○○	2.0	50
89766	○○○	2.5	60
89788	●●●	4.0	60
89791	●●●●	5.5	60

## Sets of screwdrivers

in boxes

### 7-pcs. set

Order no. 89341

ITEM NO.	Drive	mm	mm
89712	●	0.18 x 1.0	40
89713	●●	0.25 x 1.2	40
89714	●●●	0.30 x 1.5	40
89715	●●●●	0.30 x 1.8	60
89716	●●●●●	0.40 x 2.0	60
89717	●●●●●●	0.40 x 2.5	75
89718	●●●●●●●	0.50 x 3.0	75

### 7-pcs. set

Order no. 89342

ITEM NO.	Drive	mm	mm
89714	●	0.30 x 1.5	40
89416	●●	0.40 x 2.0	60
89717	●●●	0.40 x 2.5	75
89718	●●●●	0.50 x 3.0	75
89732	⊕	PH 00	40
89733	⊕	PH 0	60
89734	⊕	PH 1	80

### 7-pcs. set

Order no. 89343

ITEM NO.	Drive	mm	mm
89751	⊕	T 5	50
89752	⊕	T 6	50
89753	⊕	T 7	50
89754	⊕	T 8	60
89755	⊕	T 9	60
89756	⊕	T 10	80
89757	⊕	T 15	80

### 7-pcs. set

Order no. 89344

ITEM NO.	Drive	mm	mm
89761	○	0.7	40
89762	○○	0.9	40
89763	○○○	1.3	40
89764	○○○○	1.5	50
89765	○○○○○	2.0	50
89766	○○○○○●	2.5	60
89767	○○○○○●●	3.0	60

### 7-pcs. set

Order no. 89345

ITEM NO.	Drive	mm	mm
89784	●	2.5	60
89785	●●	3.0	60
89786	●●●	3.2	60
89787	●●●●	3.5	60
89788	●●●●●	4.0	60
89790	●●●●●●	5.0	60
89791	●●●●●●●	5.5	60

## WITTE WITTRON holder

Find out more here:

<https://www.wittetools.com/service/downloads/wittron-3d-halter/>



or here



PRO

WITTRON® VDE



Rotatable cap with ergonomic finger recess  
For one-handed rotation



Soft component  
For optimum grip



Spin zone

Slim and manageable -  
for finger-tip control



Special steel

Hardened and tempered,  
made in Germany



Insulated blade

For safe working on live  
components up to 1000 volts



Black tip

More accuracy and durability



Insulated to DIN ISO EN 60900

For safe working on live  
components up to 1000 volts







Accurate work presupposes precision tools. In particular when carrying out precision mechanical tasks and in electronics applications there is a need for finger-tip control in confined spaces and very carefully gauged application of force.

This is where the PRO WITTRON® VDE screwdriver series comes into its own. These tools feature geometries developed specifically for their field of application: a generous finger recess, even slimmer spin zones and large-sized soft components enable the worker to use finger-tip control.

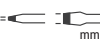

## 89930 slotted screwdrivers







ITEM NO.	 mm	 mm	 mm	 mm
89935	0.3 x 1.5	40	1.8	100
89931	0.3 x 1.8	60	1.8	100
89932	0.4 x 2.0	60	2.0	100
89933	0.4 x 2.5	75	2.5	100
89934	0.5 x 3.0	75	3.0	100

## 89940 PH screwdrivers





for PHILLIPS recess screws



ITEM NO.	 mm	 mm	 mm	 mm
89942	PH 00	40	2.5	100
89941	PH 0	60	3.0	100

## 89920 TORX® screwdrivers











ITEM NO.	 mm	 mm	 mm	 mm
89921	T 5	40	2.5	100
89922	T 6	40	2.5	100
89923	T 7	40	2.5	100
89924	T 8	60	3.0	100
89925	T 9	60	3.0	100
89926	T 10	60	3.0	100
89927	T 15	75	3.5	100

## Sets of screwdrivers

in high-impact plastic cases









### 7-pcs. set

Order no. 89367

ITEM NO.	Drive	mm	 mm
89935		0.3 x 1.5	40
89931		0.3 x 1.8	60
89932		0.4 x 2.0	60
89933		0.4 x 2.5	75
89934		0.5 x 3.0	75
89942		PH 00	40
89941		PH 0	60

### 7-pcs. set

Order no. 89368

ITEM NO.	Drive	mm	 mm
89921		T 5	40
89922		T 6	40
89923		T 7	40
89924		T 8	60
89925		T 9	60
89926		T 10	60
89927		T 15	75











## Sets of screwdrivers

in boxes









### 7-pcs. set

Order no. 89377

ITEM NO.	Drive	mm	 mm
89935		0.3 x 1.5	40
89931		0.3 x 1.8	60
89932		0.4 x 2.0	60
89933		0.4 x 2.5	75
89934		0.5 x 3.0	75
89942		PH 00	40
89941		PH 0	60

### 7-pcs. set

Order no. 89378

ITEM NO.	Drive	mm	 mm
89921		T 5	40
89922		T 6	40
89923		T 7	40
89924		T 8	60
89925		T 9	60
89926		T 10	60
89927		T 15	75

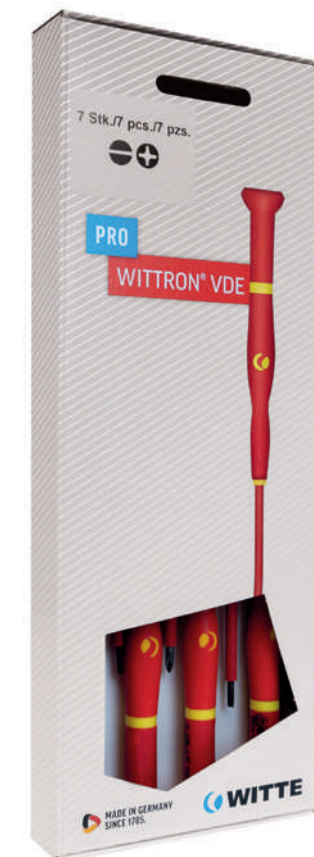

## WITTE WITTRON holder

Find out more here:

<https://www.wittetools.com/service/downloads/wittron-3d-halter/>



or here



PRO

WITTRON® ESD



Rotatable cap with ergonomic finger recess  
For one-handed rotation

Electrostatically conducting handle  
For work on electrostatically sensitive components according to ESD standard IEC 61340-5-1

Soft component  
For optimum grip

Spin zone  
Slim and manageable -  
for finger-tip control

Special steel  
Hardened and tempered,  
made in Germany

Black tip  
More accuracy and durability

The PRO WITTRON ESD screwdriver series is equipped with electrostatically conducting, dissipating handles. This enables work to be carried out on electrostatically sensitive components with a working resistance of  $10^6 - 10^9$  ohms.

The handles are electrostatically conducting to DIN EN 61340-5-1.



## 89410 slotted screwdrivers



ITEM NO.	mm	mm	mm	mm	ITEM NO.	mm	mm	mm	mm
89412	0.18 x 1.0	40	2.5	100	89416	0.50 x 3.0	75	3.0	100
89413	0.25 x 1.2	40	2.5	100	89417	0.40 x 2.0	60	2.5	100
89414	0.30 x 1.5	40	2.5	100	89418	0.40 x 2.5	75	2.5	100
89415	0.30 x 1.8	60	2.5	100					

## 89806 2K IC chip lifter



ITEM NO.	mm	mm	mm	mm
89806	1.0 x 3.5	50	3.5	100

## 89430 PH screwdrivers

for PHILLIPS recess screws



ITEM NO.		mm	mm	mm	ITEM NO.		mm	mm	mm
89432	PH 00	40	2.5	100	89434	PH 1	80	4.5	100
89433	PH 0	60	3.0	100	89435	PH 1	150	4.5	100

## 89450 TORX® screwdrivers



ITEM NO.		mm	mm	mm	ITEM NO.		mm	mm	mm
89451	T 5	50	2.5	100	89455	T 9	60	3.0	100
89452	T 6	50	2.5	100	89456	T 10	80	3.0	100
89453	T 7	50	2.5	100	89457	T 15	80	3.5	100
89454	T 8	60	3.0	100	89458	T 20	100	4.0	100

## 89480 nutdrivers



ITEM NO.	mm	mm	mm
89487	3.5	60	100
89489	4.5	60	100
89490	5.0	60	100

## Sets of screwdrivers

in high-impact plastic cases

### 7-pcs. set

Order no. 89313

ITEM NO.	Drive	mm	mm
89414	+	0.30 x 1.5	40
89416	+	0.40 x 2.0	60
89417	+	0.40 x 2.5	75
89418	+	0.50 x 3.0	75
89432	+	PH 00	40
89433	+	PH 0	60
89434	+	PH 1	80



## WITTE WITTRON holder

Find out more here:

<https://www.wittetools.com/service/downloads/wittron-3d-halter/>



or here









PRO

# Allen keys



### TORX® key wrenches

Popular TORX® tools as key wrenches.

### XZN triple-square key wrenches

Manufactured to comply strictly with DIN 65253, with grey surface finish.

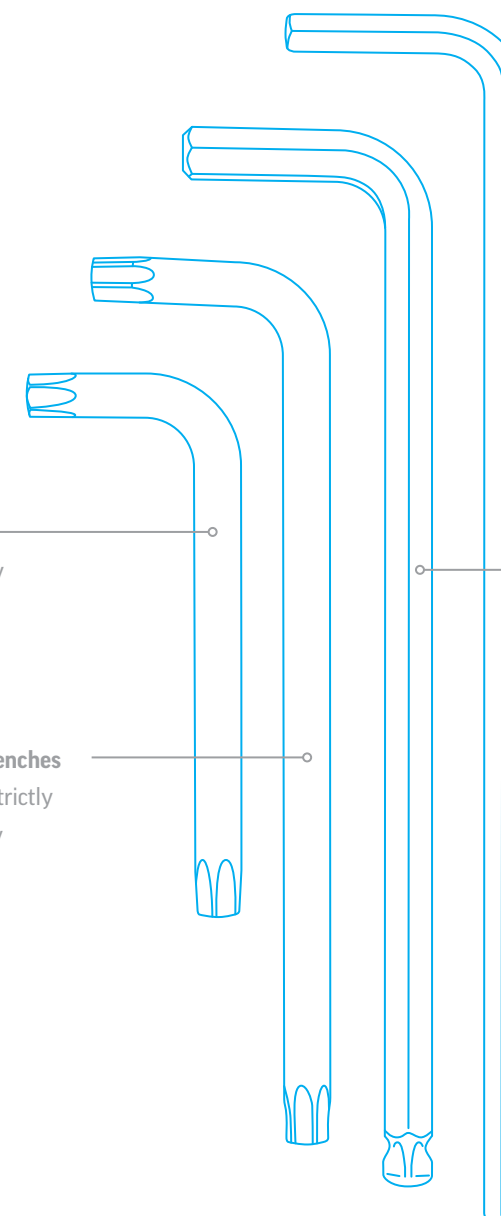

### Hexagon socket screw keys

With bevelled ends (DIN ISO 2936) - available as long and short versions.

### Allen keys with a ball-end

Easy insertion of the tool into the screw head at angles up to 25° - ideal for hard-to-reach screws.

A hardy perennial: convenient, easy to handle and extremely helpful: key wrenches are a must in any professional set of tools. WITTE makes these classic screwdriving aids into something special. All PRO key wrenches are made from high-grade chrome vanadium steel and feature excellent handling and safety due to the bevelled ends.

## 43000 Allen keys

high-grade chrome vanadium steel, bevelled ends, to DIN ISO 2936



ITEM NO.	Ø	mm	ITEM NO.	Ø	mm	ITEM NO.	Ø	mm	ITEM NO.	Ø	mm
43001	1.5	47 x 15	43009	5.5	90.5 x 35.5	43017	13.0	145 x 63	43025	21.0	211 x 96
43002	2.0	52 x 18	43010	6.0	96 x 38	43018	14.0	154 x 70	43026	22.0	222 x 102
43003	2.5	59 x 21	43011	7.0	102 x 41	43019	15.0	161 x 73	43027	24.0	248 x 114
43004	3.0	66 x 23	43012	8.0	108 x 44	43020	16.0	168 x 76	43028	27.0	277 x 127
43005	3.5	69.5 x 25.5	43013	9.0	114 x 47	43021	17.0	177 x 80	43029	30.0	310 x 142
43006	4.0	74 x 29	43014	10.0	122 x 50	43022	18.0	188 x 84	43030	32.0	347 x 157
43007	4.5	80 x 30.5	43015	11.0	129 x 53	43023	19.0	199 x 89	43031	36.0	391 x 176
43008	5.0	85 x 33	43016	12.0	137 x 47	43024	20.0	200 x 90			

## 43600 XZN triple-square key wrenches

high-grade chrome vanadium steel, to DIN 65253



ITEM NO.	Ø	mm
43601	M 5	72 x 25
43602	M 6	80 x 28
43603	M 8	90 x 32
43604	M 10	100 x 36
43605	M 12	112 x 40
43606	M 14	125 x 45

## 43100 Allen keys, long version

high-grade chrome vanadium steel, bevelled ends, to DIN ISO 2936



ITEM NO.	Ø	mm	ITEM NO.	Ø	mm	ITEM NO.	Ø	mm	ITEM NO.	Ø	mm
43101	1.5	93 x 15	43106	4.0	144 x 29	43111	7.0	197 x 41	43116	12.0	262 x 47
43102	2.0	102 x 18	43107	4.5	156 x 30.5	43112	8.0	208 x 44	43117	13.0	277 x 63
43103	2.5	116 x 21	43108	5.0	165 x 33	43113	9.0	219 x 47	43118	14.0	294 x 70
43104	3.0	129 x 23	43109	5.5	175.5 x 35.5	43114	10.0	234 x 50	43119	17.0	337 x 80
43105	3.5	140 x 25.5	43110	6.0	186 x 38	43115	11.0	247 x 53	43120	19.0	379 x 89

## 42700 Allen keys, with ball-end

high-grade chrome vanadium steel



ITEM NO.	Ø	mm	ITEM NO.	Ø	mm	ITEM NO.	Ø	mm
42715	1.5	80 x 14	42704	4.0	110 x 29	42710	10.0	200 x 49
42702	2.0	85 x 17	42705	5.0	130 x 32	42712	12.0	210 x 45
42725	2.5	90 x 19	42706	6.0	155 x 36			
42703	3.0	100 x 21	42708	8.0	175 x 42			

## 39400 TORX® key wrenches



ITEM NO.	Ø	mm	ITEM NO.	Ø	mm	ITEM NO.	Ø	mm
39454	T 5	44 x 14	39460	T 15	54 x 18	39466	T 45	83 x 29
39455	T 6	44 x 14	39461	T 20	57 x 19	39467	T 50	95 x 32
39456	T 7	48 x 16	39462	T 25	60 x 20	39468	T 55	108 x 35
39457	T 8	48 x 16	39463	T 27	64 x 22	39469	T 60	120 x 38
39458	T 9	48 x 16	39464	T 30	70 x 24			
39459	T 10	51 x 17	39465	T 40	76 x 26			





## Sets of Allen keys

### 45030 set of Allen keys, long version, 9-pcs. set

high-grade chrome vanadium steel, bevelled ends, to DIN ISO 2936

 Order no. 45050  Order no. 45030



ITEM NO.



45030

1.5-2.0-2.5-3.0-4.0-5.0-6.0-8.0-10.0

### 45031 set of ball-ended Allen keys, 9-pcs. set

high-grade chrome vanadium steel, bevelled ends, to DIN ISO 2936

 Order no. 45051  Order no. 45031



ITEM NO.



45031

1.5-2.0-2.5-3.0-4.0-5.0-6.0-8.0-10.0

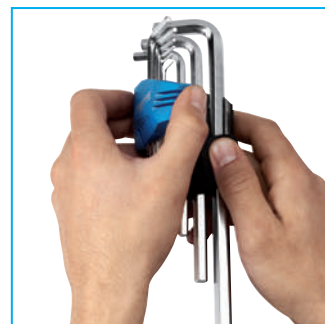

**Quickly accessible**  
All keys ready to go



**Convenient plastic cover**  
Open cover to access tools

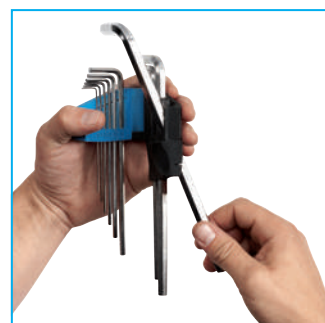

**Easy to remove**  
Tilt using the longer arm to  
release from clip

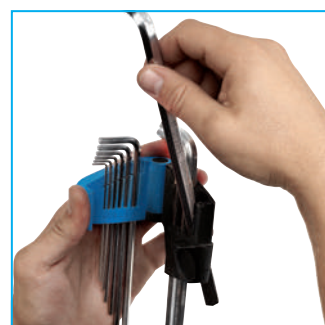

**All present and correct**  
Replace tools and close the cover

#### The advantages

- High-quality and safe: durable, sturdy plastic construction
- Compact: plenty of tools – low space requirement
- Comprehensive: all popular tool sizes included
- Better organised: tools can be removed and replaced individually



### 45032 TORX® key wrenches, 8-pcs. set, gunmetal finish

high-grade chrome vanadium steel

 Order no. 45052  Order no. 45032



ITEM NO.   
45032 T9-T10-T15-T20-T25-T27-T30-T40



### 45034 set of Allen keys, long version, 9-pcs. set

high-grade chrome vanadium steel, several colours

 Order no. 45034  Order no. 45054



ITEM NO.   
45034 1.5-2.0-2.5-3.0-4.0-5.0-6.0-8.0-10.0



### 45020 hexagonal Allen keys, 7-pcs. set

high-grade chrome vanadium steel, bevelled ends, to DIN ISO 2936



ITEM NO.   
45020 1.5-2.0-2.5-3.0-4.0-5.0-6.0

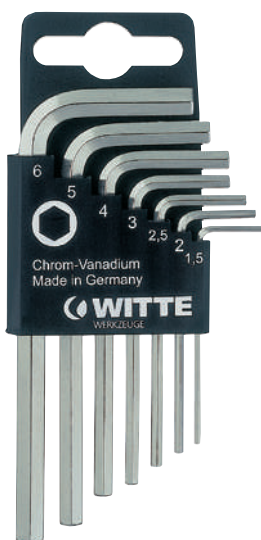

### 44440 set of ball-ended Allen keys, 9-pcs. set, Made in Germany

high-grade chrome vanadium steel, several colours

 Order no. 44440  Order no. 44450



ITEM NO.   
45035 1.5-2.0-2.5-3.0-4.0-5.0-6.0-8.0-10.0



### 45021 hexagonal Allen keys, 9-pcs. set

high-grade chrome vanadium steel, bevelled ends, to DIN ISO 2936



ITEM NO.   
45021 1.5-2.0-2.5-3.0-4.0-5.0-6.0-8.0-10.0



### 45036 TORX® key wrenches, 8-pcs. set

high-grade chrome vanadium steel, several colours

 Order no. 45036  Order no. 45056



ITEM NO.   
45036 T9-T10-T15-T20-T25-T27-T30-T40





**MAXX**

# Pliers & cutters

## 140 Pliers & cutters

Professional pliers & cutters at a glance

- 142 MAXX heavy-duty telephone engineer's plier
- 143 MAXX heavy-duty side-cutter
- 144 MAXX heavy-duty combination plier
- 146 MAXX VDE heavy-duty telephone eng. plier
- 147 MAXX VDE multifunction side-cutter
- 148 MAXX VDE heavy-duty side-cutter
- 149 MAXX VDE heavy-duty combination plier
- 150 MAXX VDE cable shear

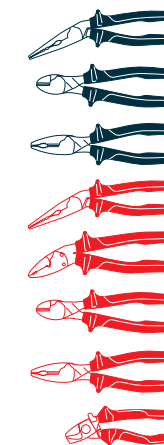

### TEST WIRES

- MH 800 N/mm<sup>2</sup> or MPa tensile strength for medium hard wire / 23 HRC
- H 1600 N/mm<sup>2</sup> or MPa tensile strength for hard wire / 47 HRC
- P 2000 N/mm<sup>2</sup> or MPa tensile strength for piano wire / 54 HRC



### 31510 heavy-duty telephone engineer's plier

Matt chrome-plated, 2-component handles cyan/black, to DIN ISO 5743

ITEM NO.	Length	MH	H	P	Weight
31510	220 mm	3.0	2.0	1.4	295 g

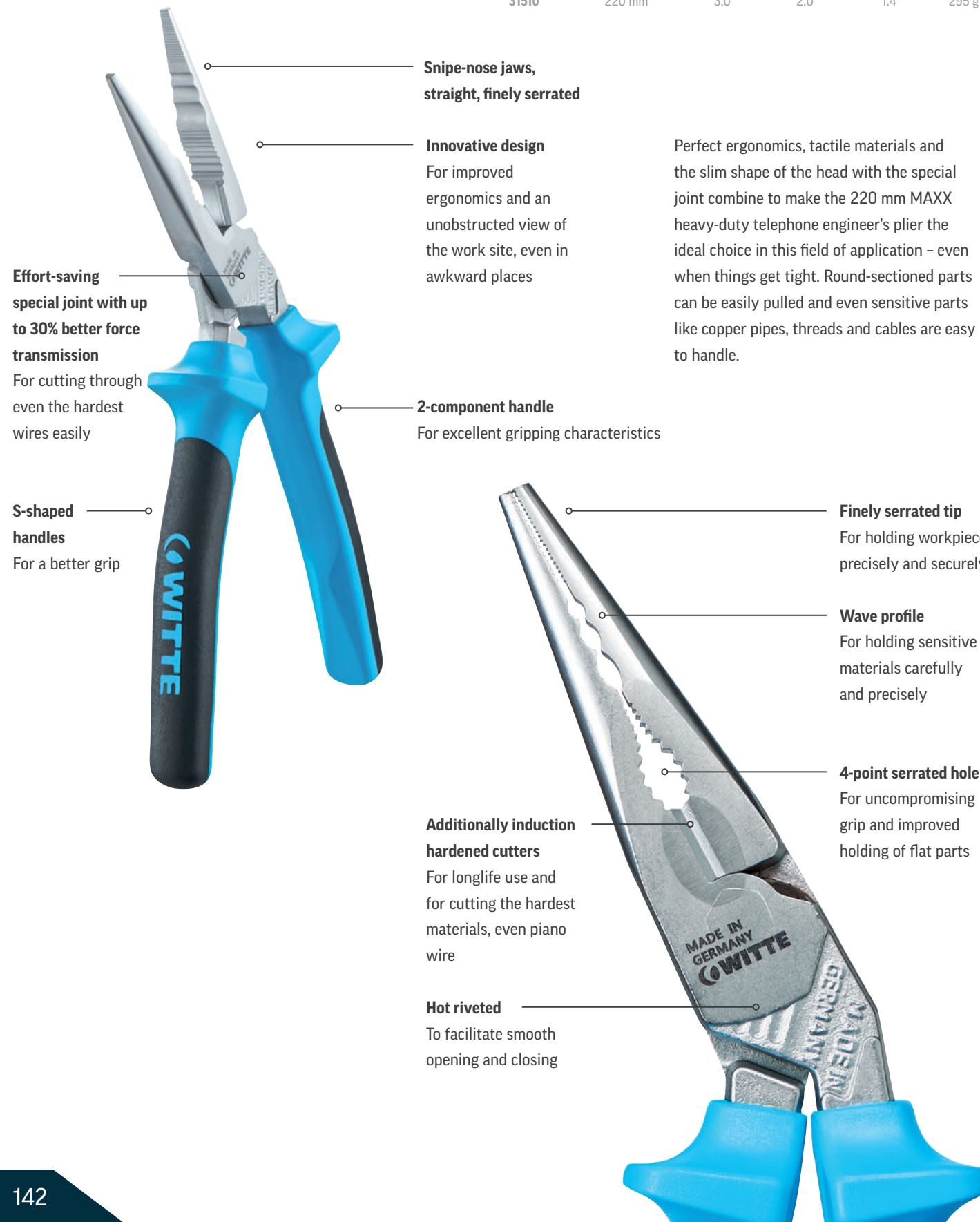

### 31511 heavy-duty side-cutter

Matt chrome-plated, 2-component handles cyan/black, to DIN ISO 5749

ITEM NO.	Length	MH	H	P	Weight
31511	180 mm	3.8	2.7	2.3	235 g





## 31512 heavy-duty combination plier

Matt chrome-plated, 2-component handles cyan/black, to DIN ISO 5746

ITEM NO.	Length	MH	H	P	Weight
31512	180 mm	3.5	2.5	2.0	210 g

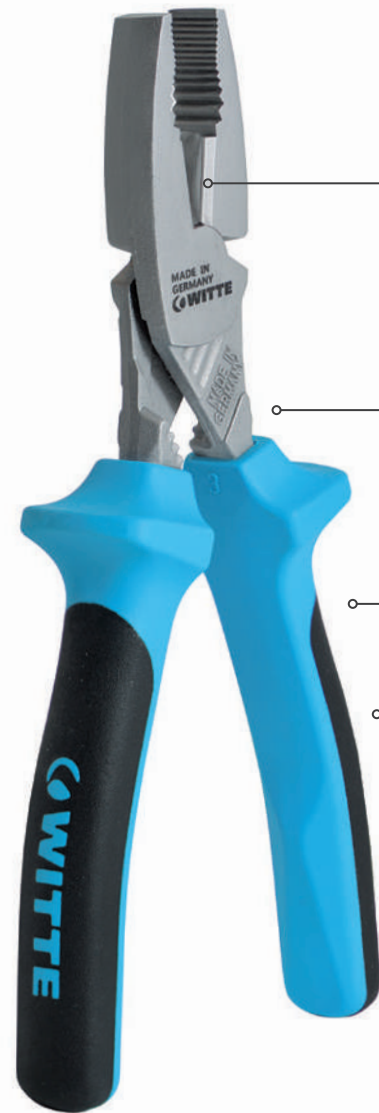

**Long, accurate cutters**  
For cutting soft and hard wires

Spring can be retrofitted

**2-component handle**  
For excellent gripping characteristics

**S-shaped handles**  
For a better grip

**Slim-line head**  
And central section, to optimise accessibility

**Effort-saving joint**  
Reduces the effort required considerably

Thanks to the extra-hard cutters, the MAXX heavy-duty combination plier will cut soft or hard wire with a minimum of effort. Compared with conventional combination pliers, the specially designed effort-saving joint requires up to 30% less effort. The finely crafted serrations make gripping workpieces a simple matter.

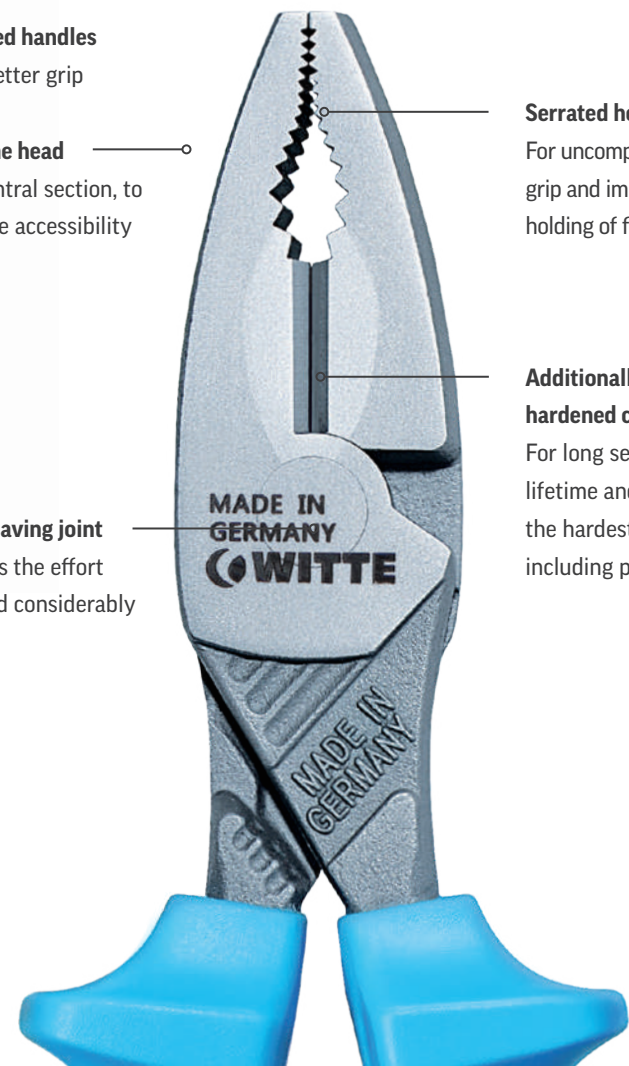

**Serrated hole**  
For uncompromising grip and improved holding of flat parts

**Additionally induction hardened cutters**  
For long service lifetime and for cutting the hardest materials, including piano wire





## 31500 VDE heavy-duty telephone engineer's plier

Matt chrome-plated, 2-component red/yellow VDE sleeves, to DIN ISO 5743 and DIN ISO EN 60900

ITEM NO.	Length	MH	H	P	Weight
31500	220 mm	3.0	2.0	1.4	295 g

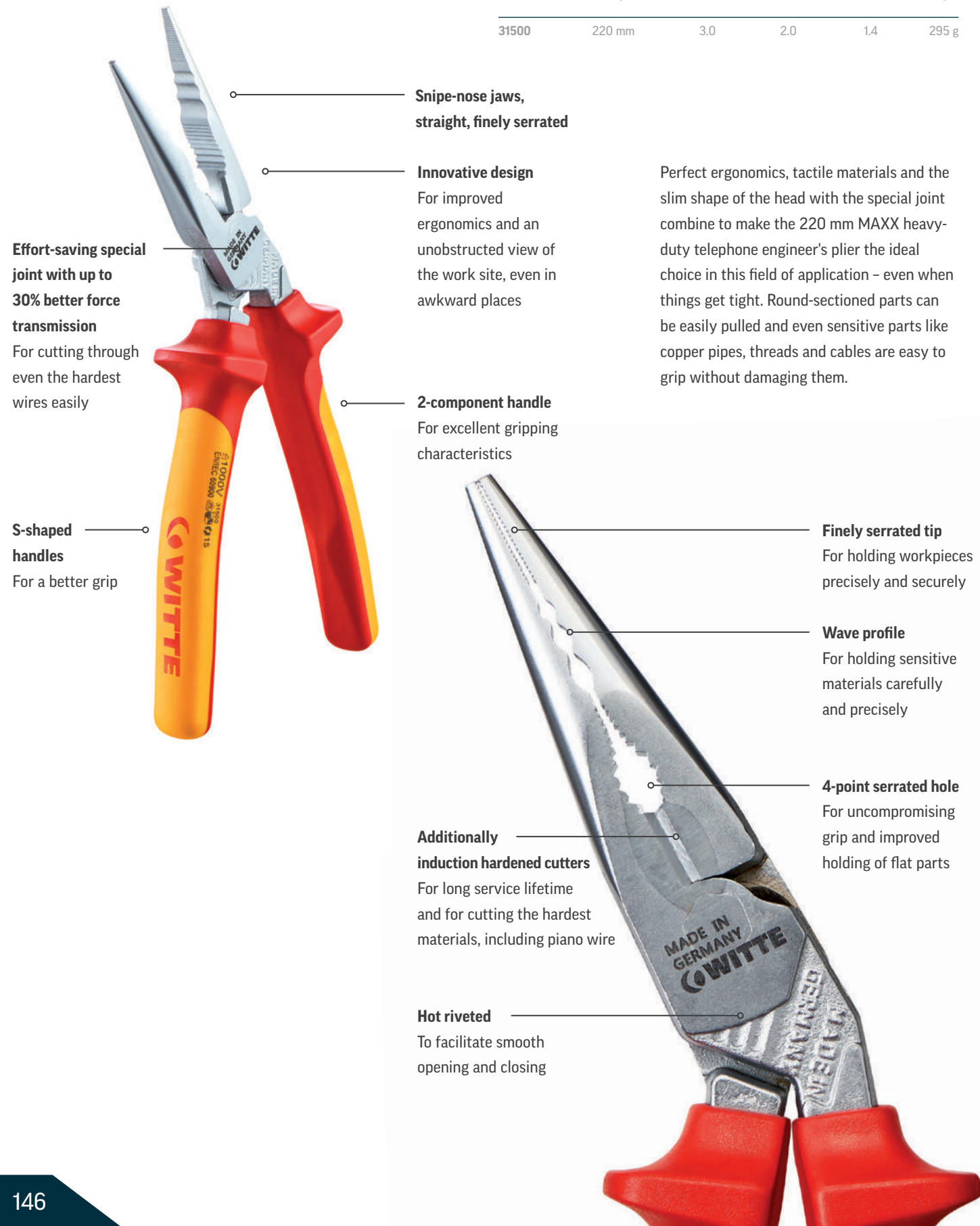

## 31501 VDE multifunction side-cutter

Matt chrome-plated, 2-component red/yellow VDE sleeves, to DIN ISO 5743 and DIN ISO EN 60900

ITEM NO.	Length	MH	H	P	Weight
31501	180 mm	3.5	2.5	2.0	270 g

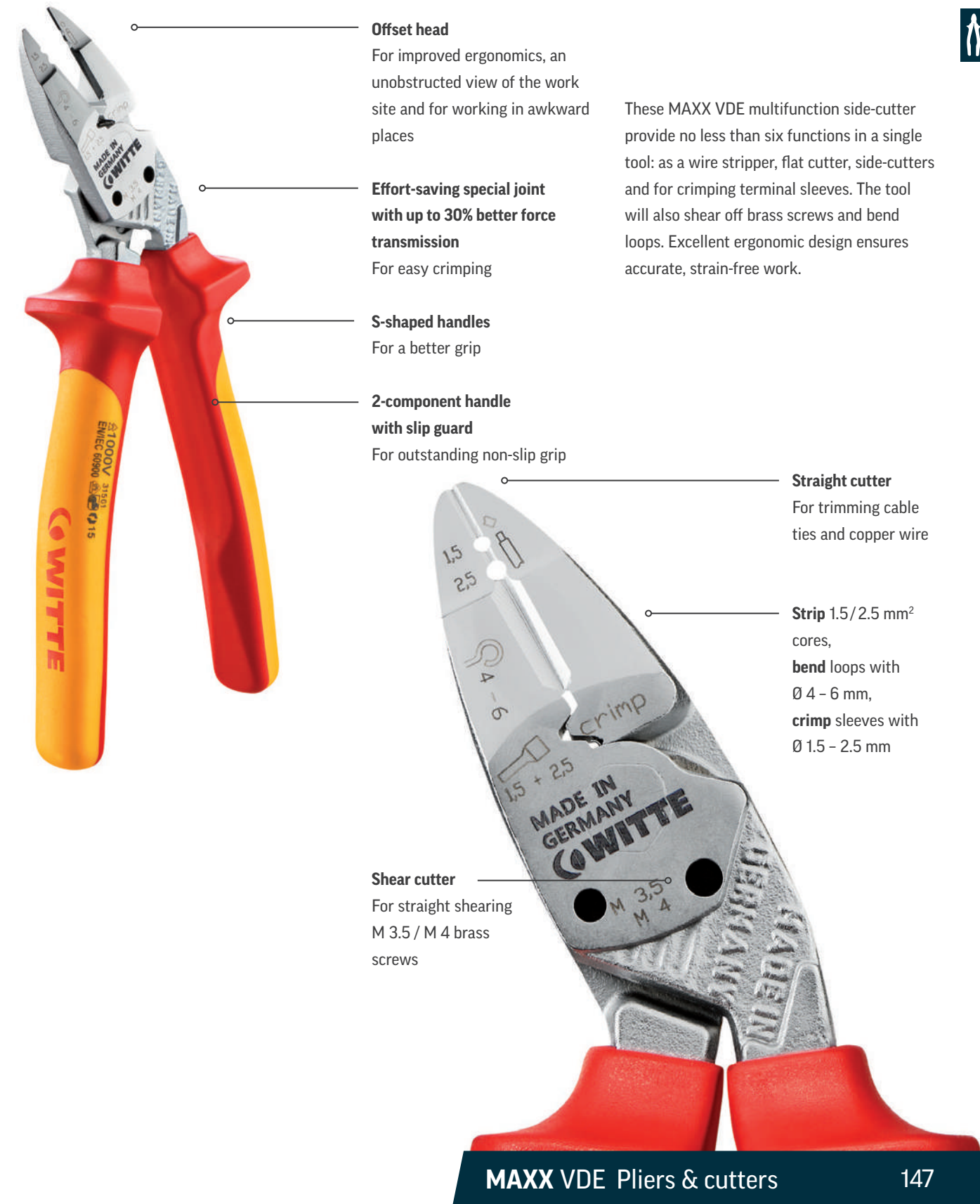



### 31502 VDE heavy-duty side-cutter

Matt chrome-plated, 2-component VDE handle coatings in red/yellow, to DIN ISO 5749 and DIN ISO EN 60900

ITEM NO.	Length	MH	H	P	Weight
31502	180 mm	3.8	2.7	2.3	235 g

The MAXX VDE heavy-duty side-cutter have been specifically developed for extremely long service lives. The cutting edges are made from best-quality steel and cut absolutely accurately – permanently. Thanks to the especially well-balanced interaction between the ergonomic design and the optimised design of the joint, remarkably little effort is required.



- 2-component handle  
For excellent gripping characteristics
- S-shaped handles  
For a better grip

**Special joint construction**  
Reduces effort required by up to 20% in comparison with conventional side-cutters.



**Cutters made of top-quality steel**  
For longlife use and for cutting the hardest materials, even piano wire

**Hot riveted**  
To facilitate smooth opening and closing

### 31503 heavy-duty VDE combination plier

Matt chrome-plated, 2-component VDE handle coatings in red/yellow, to DIN ISO 5746 and DIN ISO EN 60900

ITEM NO.	Length	MH	H	P	Weight
31503	180 mm	3.5	2.5	2.0	210 g



**Long, accurate cutters**  
For cutting soft and hard wires

Spring can be retrofitted

- 2-component handle  
For excellent gripping characteristics
- S-shaped handles  
For a better grip

**Slim-line head**  
And central section, to optimise accessibility

**Effort-saving joint**  
Reduces the effort required considerably

MAXX VDE heavy-duty combination plier, with their additionally hardened cutters, cut hard wire as easily as soft wire, with less effort. Compared with conventional combination pliers, up to 30% less effort is required. The finely crafted serrations make gripping workpieces a simple matter.

**Serrations**  
So the tool gets a firmer grip on flat workpieces

**Additionally induction hardened cutters**  
For long service lifetime and for cutting the hardest materials, including piano wire

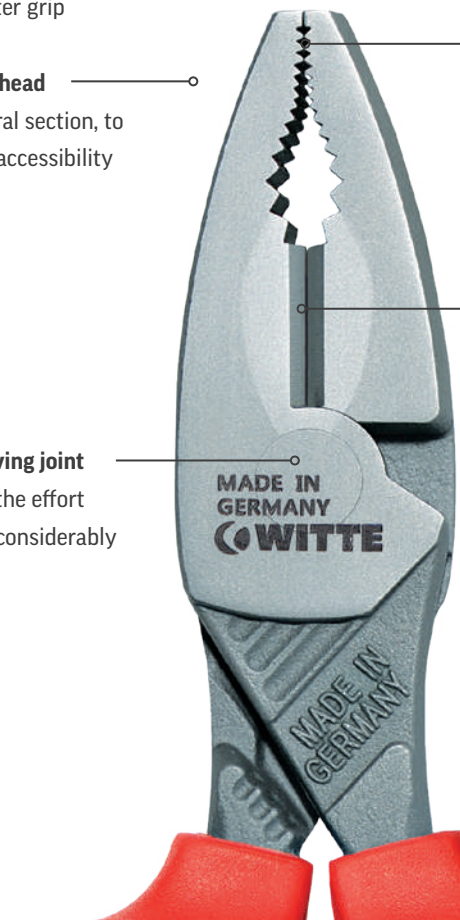

## 31504 VDE cable shear

Matt chrome-plated, 2-component red/yellow VDE sleeves, to DIN ISO 5743 and DIN ISO EN 60900

ITEM NO.	Length	Cu/Al	Weight
31504	180 mm	Ø 18 mm / 50 mm <sup>2</sup>	305 g



### One-handed operation

Easy to use thanks to the integrated spring and lock

### 2-component handles

Ergonomic design ensures strain-free, joint-friendly working

Thanks to the fine cutters, these cable shear ensure clean, extremely smooth-action, accurate cuts, in both solid and multi-stranded copper and aluminium wires.

### Finely shaped cutters

For perfect, easy cutting

### Precision joint

Ground, bolted and adjustable





**PRO**

# Pliers & cutters

## 152 Pliers & cutters

Overview of combination pliers & cutters

- 154 PRO radio & telephone engineer's plier
- 155 PRO side-cutter
- 156 PRO combination plier
- 157 PRO water pump plier
- 158 PRO VDE radio & telephone eng. plier
- 159 PRO VDE combination plier
- 160 PRO VDE wire-stripper
- 161 PRO VDE side-cutter

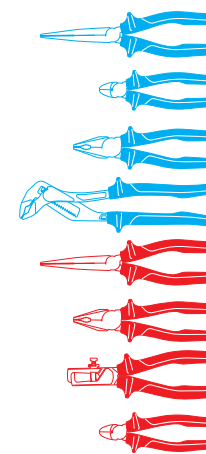

### TEST WIRES

- MH 800 N/mm<sup>2</sup> or MPa tensile strength for medium hard wire / 23 HRC
- H 1600 N/mm<sup>2</sup> or MPa tensile strength for hard wire / 47 HRC
- P 2000 N/mm<sup>2</sup> or MPa tensile strength for piano wire / 54 HRC



### 31530 telephone engineer's plier

Matt chrome-plated, 2-component handles, cyan/black, to DIN ISO 5745

ITEM NO.	Length	MH	H	P	Weight
31530	200 mm	2.8	1.8		190 g



**Firm grip, clean cuts**

Long jaws and high-grade cutting edges for precision jobs and wire cutting

**2-component handle**

For excellent gripping characteristics

**S-shaped handles**

For easier gripping and cutting actions

**Additionally induction hardened cutters**

Ideal for precision jobs and cutting wires

The straight, 200 mm long radio and telephone engineer's plier in the PRO series are ideal for precision jobs and cutting wires. Made in Germany, of course, and a perfect blend of materials from matt chrome-plated steel to the 2-component handles, that unite excellent tactile feedback with ergonomic design.

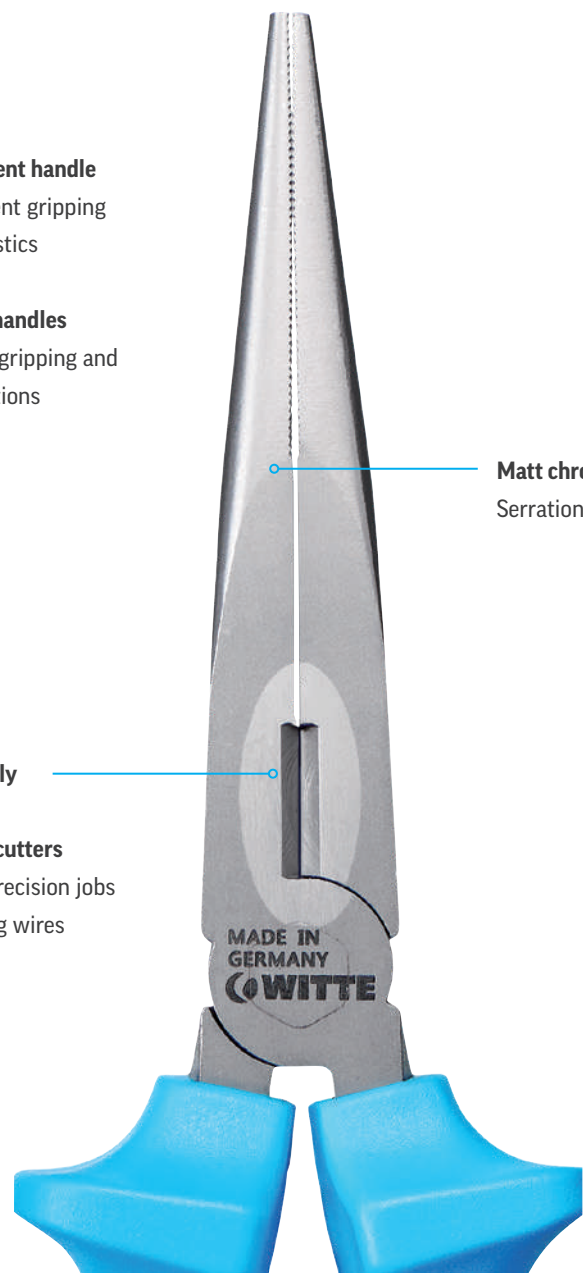

**Matt chrome-plated Serrations**

### 31531 side-cutter

Matt chrome-plated, 2-component handles, cyan/black, to DIN ISO 5749

ITEM NO.	Length	MH	H	P	Weight
31531	160 mm	3.0	2.3	1.6	220 g



**Versatile cutters**

For soft and hard wire

**2-component handle**

Tough, soft-grip handles

**S-shaped handles**

For easier gripping and cutting actions

**Accurate cutting action, cutters made of high-grade steel**  
For versatile application

The PRO side-cutter are ideal for all day-to-day applications. The precision cutters slice through hard and soft wire, while the sturdy joint ensures optimum force transmission.





### 31532 combination plier

Matt chrome-plated, 2-component handles cyan/black, to DIN ISO 5746

ITEM NO.	Length	MH	H	P	Weight
31532	180 mm	2.8	2.5		265 g



**Finely serrated jaws**  
For a powerful grip

**2-component handle**  
For excellent gripping characteristics

**S-shaped handles**  
For easier gripping and cutting actions

**Bevelled edge**  
For improved accessibility.

**Precision cutters**  
For soft and hard wire

**Matt chrome-plated**

Your daily helper in innumerable situations: the WITTE PRO combination plier. Grips tightly and cuts soft and hard wires. The bevelled edge improves accessibility.

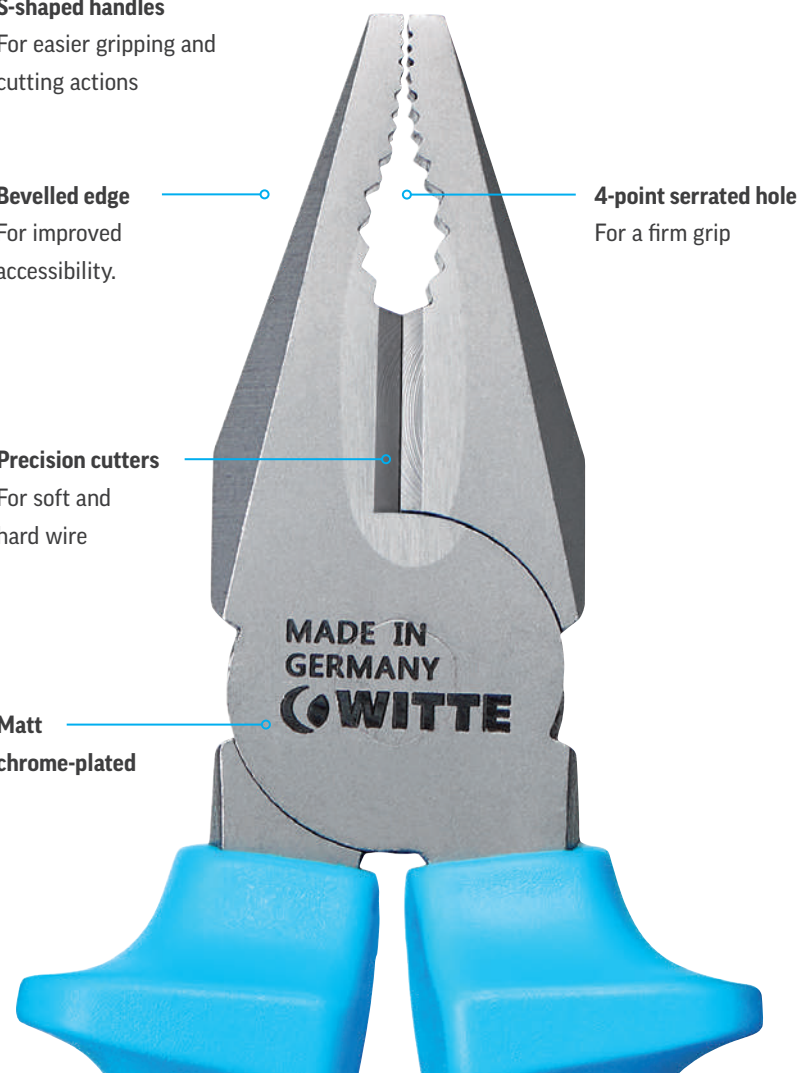

**4-point serrated hole**  
For a firm grip

### 31533 water pump plier

Matt chrome-plated, 2-component handles cyan/black, to DIN ISO 8976

ITEM NO.	Length	R	S	Weight
31533	250 mm	1/8" - 1 1/4"	6 - 38 mm	350 g



**Self-grip function**  
on pipes and nuts - safe and energy-saving

**Quick-fit adjuster**  
Allows rapid adjustment to the workpiece

**Slim but highly resilient**, thanks to best quality chrome vanadium steel

The PRO water pump plier enable extremely fast, reliable working. The tool adapts easily to changes in workpiece size due to the quick-fit adjuster. The box joint and additionally hardened teeth ensure a firm grip - even in tight corners, thanks to the slime-line construction.

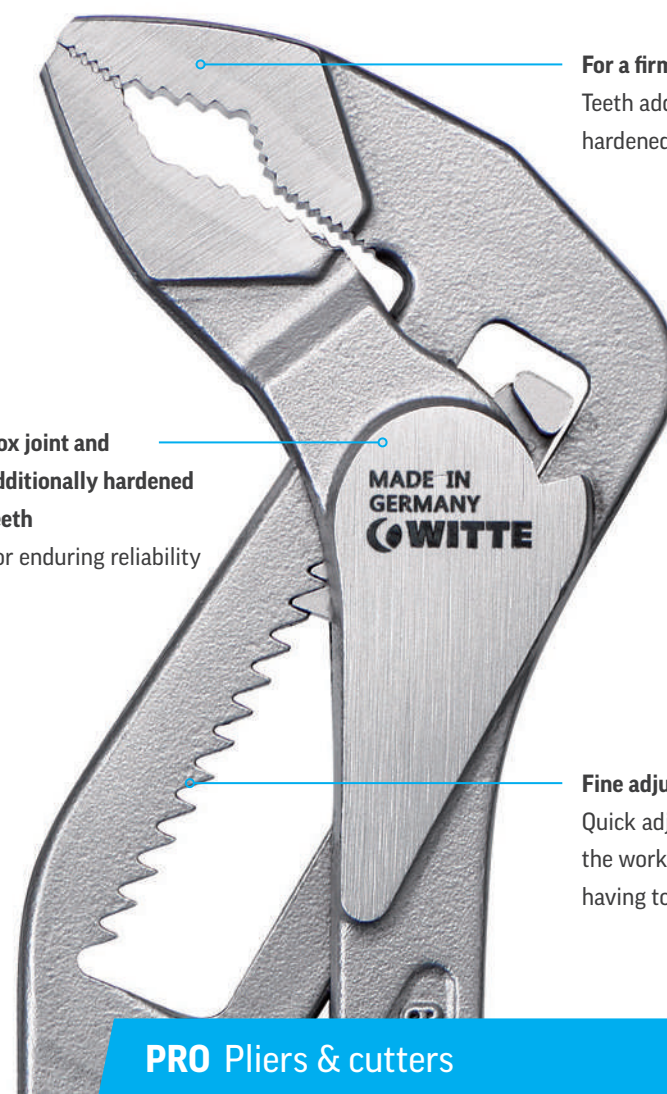

**For a firm grip**  
Teeth additionally hardened

**Box joint and additionally hardened teeth**  
For enduring reliability

**Fine adjustment**  
Quick adjustment to the workpiece without having to press a button

### 31520 VDE radio and telephone engineer's plier

Matt chrome-plated, 2-component VDE handle coatings in red/yellow, to DIN ISO 5745 and DIN ISO EN 60900

ITEM NO.	Length	MH	H	P	Weight
31520	200 mm	2.8	1.8		190 g



**Firm grip, clean cuts**

Long jaws and high-grade cutting edges for precision jobs and wire cutting

**2-component handle**

For excellent gripping characteristics

**S-shaped handles**

For easier gripping and cutting actions

The straight, 200 mm long radio and telephone engineer's plier in the PRO VDE series are ideal for precision jobs and cutting wires. Made in Germany, of course, and a perfect blend of materials from matt chrome-plated steel to the 2-component handles, that unite excellent tactile feedback with ergonomic design.

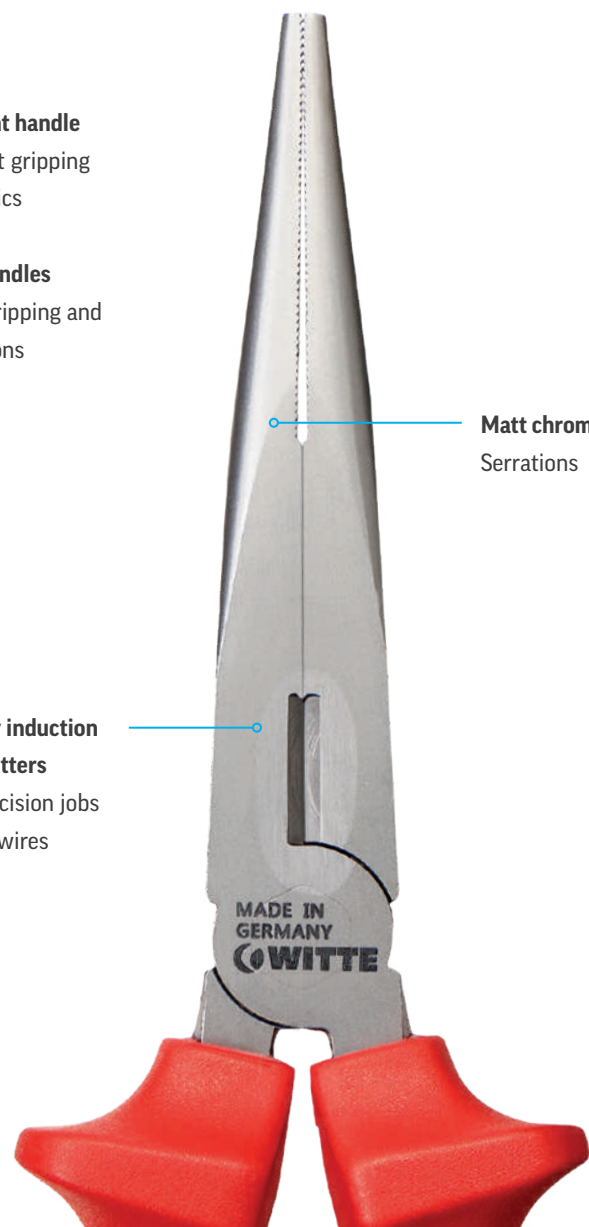

**Matt chrome-plated**  
Serrations

**Additionally induction hardened cutters**

Ideal for precision jobs and cutting wires

### 31521 VDE heavy-duty combination plier

Matt chrome-plated, 2-component VDE handle coatings in red/yellow, to DIN ISO 5746 and DIN ISO EN 60900

ITEM NO.	Length	MH	H	P	Weight
31521	180 mm	2.8	2.5	1.6	265 g



**Finely serrated jaws**

For a powerful grip.

**2-component handle**

For outstanding grip

**S-shaped handles**

For easier gripping and cutting actions

**Bevelled edge**

For improved accessibility

**Precision cutters**

For soft and hard wire

**Matt chrome-plated**

Your daily helper in innumerable situations: the WITTE PRO VDE combination plier. Grips tightly and cuts soft and hard wires. The bevelled edge improves accessibility. Like all tools made by WITTE, the PRO combination plier fit snugly in your hand.

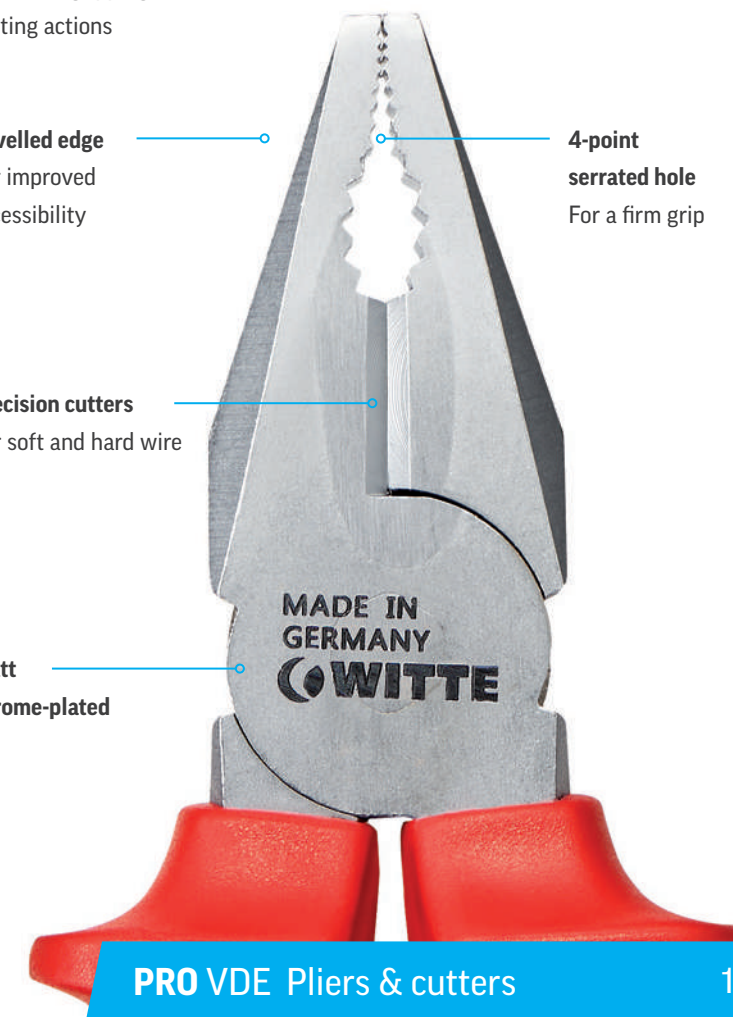

**4-point serrated hole**  
For a firm grip



### 31522 VDE wire-stripper

Matt chrome-plated, 2-component VDE handle coatings in red/yellow, to DIN ISO 5743 and DIN ISO EN 60900

ITEM NO.	Length	Max. core diameter	Weight
31522	160 mm	Ø 5 mm / 10 mm <sup>2</sup>	165 g



**Accurate working**  
With spring, set screw and locknut

These wire-stripper remove the plastic or rubber insulation sheath from all popular flexible and solid wires easily and without damaging the conductor. The diameter of the conductor is quickly and accurately set using the set screw.

**2-component handle**  
For minimum effort

**S-shaped handles**  
For easier gripping and cutting actions

Gives access to hard-to-reach places

**The turning point**  
For peak accuracy

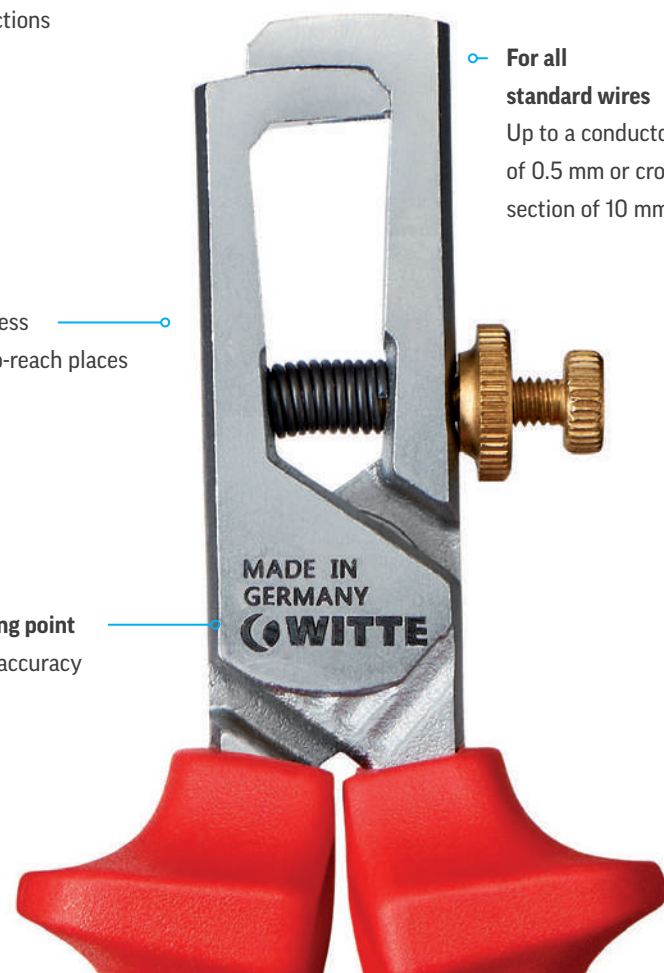

**For all standard wires**  
Up to a conductor Ø of 0.5 mm or cross-section of 10 mm<sup>2</sup>

### 31523 VDE side-cutter

Matt chrome-plated, 2-component VDE handle coatings in red/yellow, to DIN ISO 5749 and DIN ISO EN 60900

ITEM NO.	Length	MH	H	P	Weight
31523	160 mm	3.0	2.3	1.6	220 g



**Versatile cutters**  
For soft and hard wire

The PRO VDE side-cutter are ideal for all day-to-day applications. The precision cutters slice through hard and soft wire, while the sturdy joint ensures optimum force transmission.

**2-component handle**  
Tough, soft-grip handles

**S-shaped handles**  
For easier gripping and cutting actions

**Accurate cutting action, cutters made of high-grade steel**  
For versatile application





**MAXX**

Bits



**162 Bits**

Professional bits at a glance

- 164 MAXX Impact 
- 170 MAXX Stainless 
- 174 MAXX Extra hard 
- 176 MAXX TIN 
- 184 MAXX Diamond 



# MAXX

## Impact bits

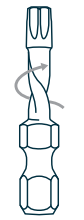

Particularly elastic  
for use with impact  
screwdrivers

Professional battery-powered impact screwdrivers are becoming ever more powerful. Time for the WITTE impact bit. Thanks to its individual torsional construction and the special heat-treatment, it provides much increased service lifetimes compared with conventional bits. The elastic material absorbs the impact of the screwdriving action and effectively protects the bit.

The compact construction means the bits, with a length of 38 mm, can be used directly in impact screwdriver without a holder.

### PH for PHILLIPS recess screws



ITEM NO.	+	mm	1/4" drive
28520	PH 1	38	E6.3
<b>28521</b>	PH 2	<b>38</b>	<b>E6.3</b>
28522	PH 3	38	E6.3

### PZ for POZIDRIV screws



ITEM NO.	+	mm	1/4" drive
28523	PZ 1	38	E6.3
<b>28524</b>	PZ 2	<b>38</b>	<b>E6.3</b>
28525	PZ 3	38	E6.3

### TORX®



ITEM NO.	+	mm	1/4" drive
28490	T 15	38	E6.3
<b>28491</b>	T 20	<b>38</b>	<b>E6.3</b>
28492	T 25	38	E6.3
<b>28493</b>	T 30	<b>38</b>	<b>E6.3</b>
28494	T 40	38	E6.3

### DRY WALL Impact bit PH2



ITEM NO.	+	mm	1/4" drive
28621	PH 2	38	E6.3

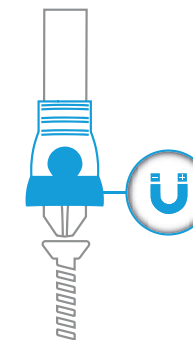

## PH

for PHILLIPS recess screws



1 unit on a blister card

ITEM NO.	+	mm	1/4" drive
28376	PH 1	38	E6,3
<b>28377</b>	PH 2	<b>38</b>	<b>E6,3</b>
28378	PH 3	38	E6,3

## PZ

for POZIDRIV screws



1 unit on a blister card

ITEM NO.	+	mm	Antrieb 1/4"
28379	PZ 1	38	E6,3
<b>28380</b>	<b>PZ 2</b>	<b>38</b>	<b>E6,3</b>
28381	PZ 3	38	E6,3

## TORX®



1 unit on a blister card

ITEM NO.	Torx	mm	1/4" drive
28371	T 15	38	E6,3
<b>28372</b>	<b>T 20</b>	<b>38</b>	<b>E6,3</b>
28373	T 25	38	E6,3
<b>28374</b>	<b>T 30</b>	<b>38</b>	<b>E6,3</b>
28375	T 40	38	E6,3



Article may deviate from illustration



Article may deviate from illustration



Article may deviate from illustration

## PH

for PHILLIPS recess screws



3 bits in plastic case

ITEM NO.	+	mm	1/4" drive
428555	PH 1	38	E6,3
<b>428556</b>	<b>PH 2</b>	<b>38</b>	<b>E6,3</b>
428557	PH 3	38	E6,3

## PZ

for POZIDRIV screws



3 bits in plastic case

ITEM NO.	+	mm	1/4" drive
428558	PZ 1	38	E6,3
<b>428559</b>	<b>PZ 2</b>	<b>38</b>	<b>E6,3</b>
428560	PZ 3	38	E6,3

## TORX®



3 bits in plastic case

ITEM NO.	Torx	mm	1/4" drive
428550	T 15	38	E6,3
<b>428551</b>	<b>T 20</b>	<b>38</b>	<b>E6,3</b>
428552	T 25	38	E6,3
<b>428553</b>	<b>T 30</b>	<b>38</b>	<b>E6,3</b>
428554	T 40	38	E6,3



Article may deviate from illustration



Article may deviate from illustration



Article may deviate from illustration



### COMBIT-BOX® IMPACT, 6-pcs. set

Order no. 28570 Order no. 33000

Qty	ITEM NO.	Drive	mm	1/4" drive
1	28490	T 15	38 mm	E6.3
1	28491	T 20	38 mm	E6.3
2	28492	T 25	38 mm	E6.3
1	28493	T 30	38 mm	E6.3
1	28494	T 40	38 mm	E6.3



### COMBIT-BOX® IMPACT, 10-pcs. set

Order no. 28477 Order no. 28478

Qty	ITEM NO.	Drive	mm	1/4" drive
1	28376	PH 1	38 mm	E6.3
1	28377	PH 2	38 mm	E6.3
1	28378	PH 3	38 mm	E6.3
1	28379	PZ 1	38 mm	E6.3
1	28380	PZ 2	38 mm	E6.3
1	28381	PZ 3	38 mm	E6.3
1	28371	T 15	38 mm	E6.3
1	28372	T 20	38 mm	E6.3
1	28373	T 25	38 mm	E6.3
1	28374	T 30	38 mm	E6.3

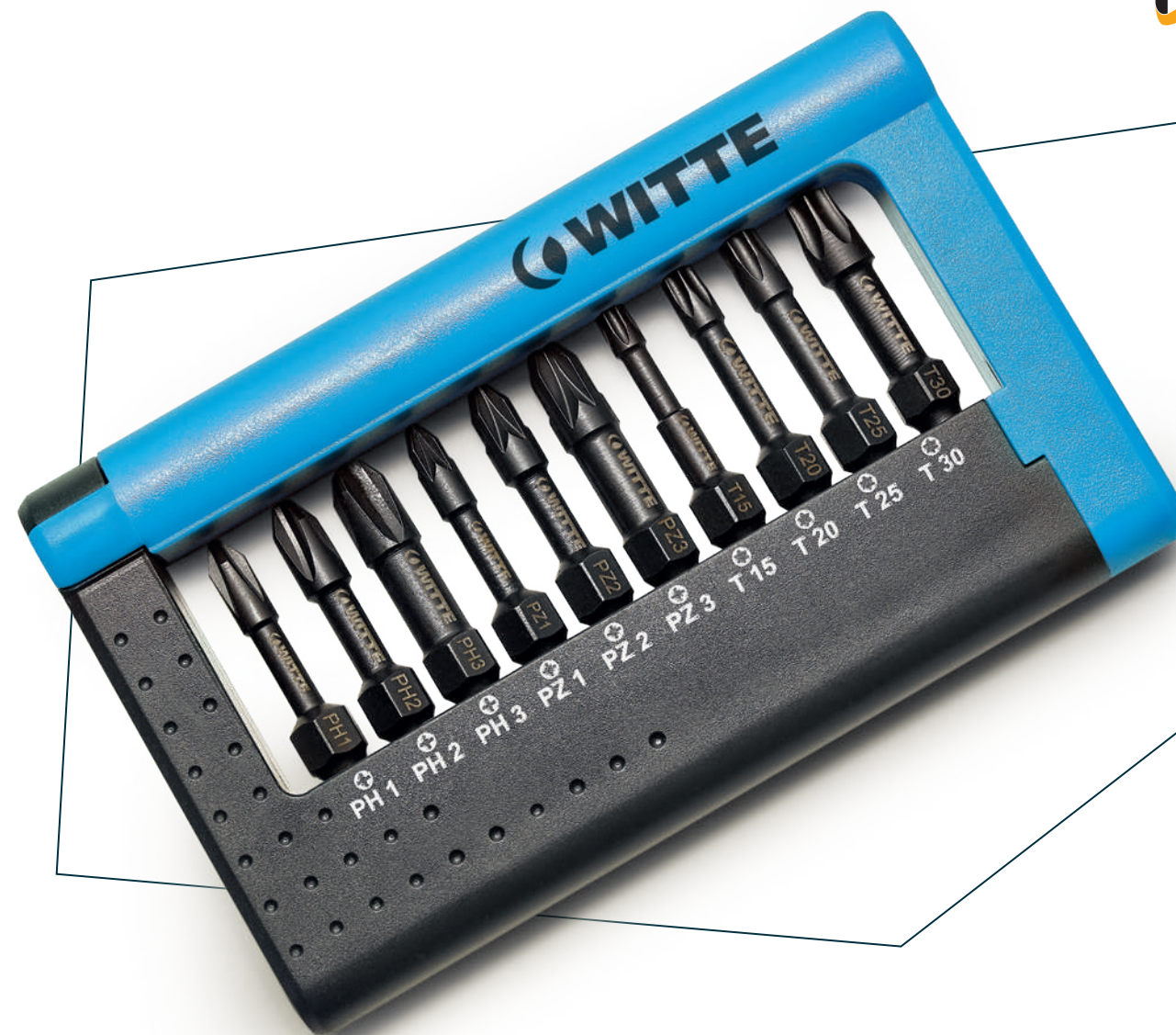
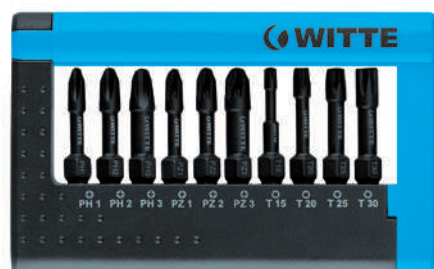

### 28430 IMPACT BIT SET, 21-pcs. set

Qty	ITEM NO.	Drive	mm	1/4" drive
1	26294		60 mm	E6.3
1	28520	PH 1	38 mm	E6.3
2	28521	PH 2	38 mm	E6.3
2	28522	PH 3	38 mm	E6.3
2	28523	PZ 1	38 mm	E6.3
1	28524	PZ 2	38 mm	E6.3
2	28525	PZ 3	38 mm	E6.3
2	28490	T 15	38 mm	E6.3
2	28491	T 20	38 mm	E6.3
2	28492	T 25	38 mm	E6.3
2	28493	T 30	38 mm	E6.3
2	28494	T 40	38 mm	E6.3



### COMBIT-BOX®

#### The advantages

- High-quality and safe: durable, sturdy plastic construction
- Compact: plenty of tools – low space requirement
- Comprehensive: all popular tool sizes included



Open the box by twisting the upper part slightly ...



... which gives easy access to the bits and bit holder.



Try the convenient stand function

**MAXX**

# Stainless bits



For safe working with  
stainless steel screws

If stainless steel screws are not tightened with stainless steel tools, there is likely to be abrasion. This often results in extraneous rust and can even cause pitting corrosion that jeopardises safety. WITTE stainless bits are specially vacuum ice-hardened for use in professional work environments and boast special hardness and strength characteristics. This weather and corrosion resistant material enables it to be used outdoors, in solar technology, marine engineering, the food processing industry and many other sensitive fields of application.

## PH for PHILLIPS recess screws



DIN ISO1173

ITEM NO.	+	mm	1/4" drive
28501	PH 1	25	C6.3
28502	PH 2	25	C6.3
28503	PH 3	25	C6.3

## PZ for POZIDRIV screws



DIN ISO1173

ITEM NO.	+	mm	1/4" drive
28511	PZ 1	25	C6.3
28512	PZ 2	25	C6.3
28513	PZ 3	25	C6.3

## TORX®



DIN ISO1173

ITEM NO.	+	mm	1/4" drive
28530	T 10	25	C6.3
28531	T 15	25	C6.3
28532	T 20	25	C6.3
28533	T 25	25	C6.3
28534	T 27	25	C6.3
28535	T 30	25	C6.3
28536	T 40	25	C6.3



EDELSTAHL  
**Rostfrei**  
INOX  
STAINLESS STEEL



## PH

for PHILLIPS recess screws



1 unit on a blister card

ITEM NO.	Drive	Length mm	1/4" drive
26511	PH 1	25	C6.3
<b>26512</b>	PH 2	25	<b>C6.3</b>
26513	PH 3	25	C6.3

## PZ

for POZIDRIV screws



1 unit on a blister card

ITEM NO.	Drive	Length mm	1/4" drive
26521	PZ 1	25	C6.3
<b>26522</b>	PZ 2	25	<b>C6.3</b>
26523	PZ 3	25	C6.3

## TORX®



1 unit on a blister card

ITEM NO.	Drive	Length mm	1/4" drive
26530	T 10	25	C6.3
<b>26531</b>	T 15	25	<b>C6.3</b>
26532	T 20	25	C6.3
<b>26533</b>	T 25	25	<b>C6.3</b>
26534	T 27	25	C6.3
<b>26535</b>	T 30	25	<b>C6.3</b>
26536	T 40	25	C6.3



Article may deviate from illustration



Article may deviate from illustration



Article may deviate from illustration

## RATCHDRIVE® STAINLESS

Order no. 25103

Qty	ITEM NO.	Drive	Length mm	1/4" drive
1			60	E6.3
1	<b>28530</b>	T 10	25	<b>C6.3</b>
1	28531	T 15	25	C6.3
1	<b>28532</b>	T 20	25	<b>C6.3</b>
1	28533	T 25	25	C6.3
1	<b>28535</b>	T 30	25	<b>C6.3</b>
1	28536	T 40	25	C6.3



Application see p. 183

## COMBIT-BOX® STAINLESS. 7-pcs. set

Order no. 28556 Order no. 33100

Qty	ITEM NO.	Drive	Length mm	1/4" drive
1			60	E6.3
1	<b>28530</b>	T 10	25	<b>C6.3</b>
1	28531	T 15	25	C6.3
1	<b>28532</b>	T 20	25	<b>C6.3</b>
1	28533	T 25	25	C6.3
1	<b>28535</b>	T 30	25	<b>C6.3</b>
1	28536	T 40	25	C6.3



Application see p. 169

## COMBIT-BOX® STAINLESS. 11-pcs. set

Order no. 28451 Order no. 28461

Qty	ITEM NO.	Drive	Length mm	1/4" drive
1			60	E6.3
1	<b>28530</b>	T 10	25	<b>C6.3</b>
1	28531	T 15	25	C6.3
1	<b>28532</b>	T 20	25	<b>C6.3</b>
1	28533	T 25	25	C6.3
1	<b>28535</b>	T 30	25	<b>C6.3</b>
1	28536	T 40	25	C6.3
1	<b>28501</b>	PH 1	25	<b>C6.3</b>
1	28502	PH 2	25	C6.3
1	<b>28511</b>	PZ 1	25	<b>C6.3</b>
1	28512	PZ 2	25	C6.3



Application see p. 169

# MAXX

## Extra-hard bits



Extra-hard bits for low and uniformly increasing torques

WITTE extra-hard industrial bits are particularly well suited to fastener tightening at low, but steadily increasing torques during which large amounts of wear & tear occur, such as during cam-out. The special hardness of 62-64 HRC guarantees long service lifetimes.

### PH for PHILLIPS recess screws



Extra hard  
DIN ISO1173

ITEM NO.	+	mm	1/4" drive
27120	PH 1	25	C6.3
27121	PH 2	25	C6.3
27122	PH 3	25	C6.3



Extra hard, truncated tip  
DIN ISO1173

ITEM NO.	+	mm	1/4" drive
27123	PH 2	25	C6.3

### PZ for POZIDRIV screws



Extra hard  
DIN ISO1173

ITEM NO.	+	mm	1/4" drive
27245	PZ 1	25	C6.3
27246	PZ 2	25	C6.3
27247	PZ 3	25	C6.3



Extra hard, truncated tip  
DIN ISO1173

ITEM NO.	+	mm	1/4" drive
27248	PZ 2	25	C6.3



# MAXX

## TIN bits



Optimum resistance to wear thanks to very hard titanium nitride (TIN) coating

The titanium nitride coating on the bits has a hardness of approx. 2800 HV and is ideally suited to screw-tightening sequences.

Thanks to the longer lifetimes and much reduced retooling times, there are considerable saving effects here.



### PH for PHILLIPS recess screws



DIN ISO1173

ITEM NO.	+	mm	1/4" drive
28421	PH 1	25	6.3 mm
28422	PH 2	25	6.3 mm
28423	PH 3	25	6.3 mm

ITEM NO.	+	mm	1/4" drive
27320	PH 1	25	C6.3
27321	PH 2	25	C6.3
27322	PH 3	25	C6.3



DIN ISO1173

ITEM NO.	+	mm	1/4" drive
27551	PH 1	50	E6.3
27552	PH 2	50	E6.3
27553	PH 3	50	E6.3

### PZ for POZIDRIV screws



DIN ISO1173

ITEM NO.	+	mm	1/4" drive
28445	PZ 1	25	6.3 mm
28446	PZ 2	25	6.3 mm
28447	PZ 3	25	6.3 mm

ITEM NO.	+	mm	1/4" drive
27345	PZ 1	25	C6.3
27346	PZ 2	25	C6.3
27347	PZ 3	25	C6.3



DIN ISO1173

ITEM NO.	+	mm	1/4" drive
27541	PZ 1	50	E6.3
27542	PZ 2	50	E6.3
27543	PZ 3	50	E6.3

### Slotted



DIN ISO1173

DIN ISO1173

ITEM NO.	mm	mm	1/4" drive
26431	0.6 x 4.5	25	C6.3
26432	0.8 x 5.5	25	C6.3
26434	1.2 x 6.5	25	C6.3

ITEM NO.	mm	mm	1/4" drive
27531	0.6 x 4.5	50	E6.3
27532	0.8 x 5.5	50	E6.3
27534	1.2 x 6.5	50	E6.3

## TORX®



DIN ISO1173

ITEM NO.	Symbol	mm	1/4" drive
29513	T 10	25	C6.3
<b>29514</b>	T 15	25	<b>C6.3</b>
29515	T 20	25	C6.3
<b>29516</b>	T 25	25	<b>C6.3</b>
29517	T 27	25	C6.3
<b>29518</b>	T 30	25	<b>C6.3</b>
29519	T 40	25	C6.3



DIN ISO1173

ITEM NO.	Symbol	mm	1/4" drive
<b>29613</b>	T 10	50	<b>E6.3</b>
<b>29614</b>	T 15	50	<b>E6.3</b>
29615	T 20	50	E6.3
<b>29616</b>	T 25	50	<b>E6.3</b>
29617	T 27	50	E6.3
<b>29618</b>	T 30	50	<b>E6.3</b>
29619	T 40	50	E6.3

## TORX® TAMPER RESISTANT



DIN ISO1173

ITEM NO.	Symbol	mm	1/4" drive
29593	TR 10	25	C6.3
<b>29594</b>	TR 15	25	<b>C6.3</b>
29595	TR 20	25	C6.3
<b>29596</b>	TR 25	25	<b>C6.3</b>
29597	TR 27	25	C6.3
<b>29598</b>	TR 30	25	<b>C6.3</b>
29599	TR 40	25	C6.3

## PH

for PHILLIPS recess screws



2 unit on a blister card

ITEM NO.	Symbol	mm	1/4" drive
27324	PH 1	25	C6.3
<b>26708</b>	PH 2	25	<b>C6.3</b>
27326	PH 3	25	C6.3

## PZ

for POZIDRIV screws



2 unit on a blister card

ITEM NO.	Symbol	mm	1/4" drive
26661	PZ 1	25	C6.3
<b>26662</b>	PZ 2	25	<b>C6.3</b>
26663	PZ 3	25	C6.3



Article may deviate from illustration



Article may deviate from illustration

## PH

for PHILLIPS recess screws



ITEM NO.	Symbol	Qty	mm	1/4" drive
427320	PH 1	10	25	C6.3
<b>427321</b>	PH 2	10	25	<b>C6.3</b>
427322	PH 3	10	25	C6.3

## PZ

for POZIDRIV screws



ITEM NO.	Symbol	Qty	mm	1/4" drive
427345	PZ 1	10	25	C6.3
<b>427346</b>	PZ 2	10	25	<b>C6.3</b>
427347	PZ 3	10	25	C6.3

## PH BITFLEX

for PHILLIPS recess screws



1 unit on a blister card

ITEM NO.	Symbol	mm	1/4" drive
26795	PH 1	25	6.3 mm
<b>26796</b>	PH 2	25	<b>6.3 mm</b>
26797	PH 3	25	6.3 mm

## PZ BITFLEX

for POZIDRIV screws



1 unit on a blister card

ITEM NO.	Symbol	mm	1/4" drive
26825	PZ 1	25	6.3 mm
<b>26826</b>	PZ 2	25	<b>6.3 mm</b>
26827	PZ 3	25	6.3 mm



Article may deviate from illustration



Article may deviate from illustration

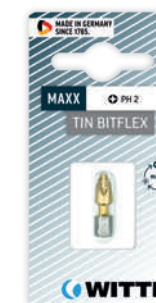

Article may deviate from illustration

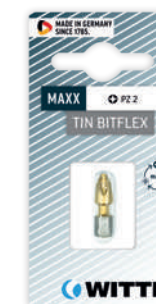

Article may deviate from illustration



### PH BITFLEX TIN

for PHILLIPS recess screws

in plastic case

ITEM NO.	+	Qty	mm	1/4" drive
428422	PH 2	15	25	6.3 mm



Article may deviate from illustration

### PZ BITFLEX TIN

for POZIDRIV screws

in plastic case

ITEM NO.	+	Qty	mm	1/4" drive
428446	PZ 2	15	25	6.3 mm



Article may deviate from illustration

### PH TIN - 50 MM

for PHILLIPS recess screws

in plastic case

ITEM NO.	+	Qty	mm	1/4" drive
427552	PH 2	5	50	E6.3



Article may deviate from illustration

### PZ TIN - 50 MM

for POZIDRIV screws

in plastic case

ITEM NO.	+	Qty	mm	1/4" drive
427542	PZ 2	5	50	E6.3



Article may deviate from illustration

### COMBIT-BOX® BITFLEX TIN, 7-pcs. set

Order no. 28555 Order no. 33200

Qty	+	ITEM NO.	Drive	mm	1/4" drive
1		26294		60	E6.3
1	+	28421	PH 1	25	C6.3
1	+	28422	PH 2	25	C6.3
1	+	28423	PH 3	25	C6.3
1	+	28445	PZ 1	25	C6.3
1	+	28446	PZ 2	25	C6.3
1	+	28447	PZ 3	25	C6.3



Application see p. 169

### COMBIT-BOX® BITFLEX TIN, 11-pcs. set

Order no. 28453 Order no. 28463

Qty	+	ITEM NO.	Drive	mm	1/4" drive
1		26294		60	E6.3
1	+	28421	PH 1	25	C6.3
3	+	28422	PH 2	25	C6.3
1	+	28423	PH 3	25	C6.3
1	+	28445	PZ 1	25	C6.3
3	+	28446	PZ 2	25	C6.3
1	+	28447	PZ 3	25	C6.3



Application see p. 169

### RATCHDRIVE® TIN

Order no. 25104

Qty	+	ITEM NO.	Drive	mm	1/4" drive
1				60	E6.3
1	+	27320	PH 1	25	C6.3
1	+	27321	PH 2	25	C6.3
1	+	27322	PH 3	25	C6.3
1	+	27345	PZ 1	25	C6.3
1	+	27346	PZ 2	25	C6.3
1	+	27347	PZ 3	25	C6.3



Application see p. 183

### RATCHDRIVE® BITFLEX TIN

Order no. 25105

Qty	+	ITEM NO.	Drive	mm	1/4" drive
1				60	E6.3
1	+	28421	PH 1	25	C6.3
1	+	28422	PH 2	25	C6.3
1	+	28423	PH 3	25	C6.3
1	+	28445	PZ 1	25	C6.3
1	+	28446	PZ 2	25	C6.3
1	+	28447	PZ 3	25	C6.3



Application see p. 183





## RATCHDRIVE®-BOX

### The advantages

- Powerful, fine action ratchet mechanism, integrated in a compact bit box
- One quick-change holder and six high-quality bits in various sets provide just the right tool for every screwdriving job



Easy removal of the bits and quick-change holder.



Insert the quick-change holder (to change ratchet direction, simply insert the bit holder from the other side) ...



and you can apply the convenient, safe ratchet function.



# MAXX

## Diamond bits



Low contact pressure thanks to fine diamond particles that bite into the screw head

MAXX Diamond bits with the microparticle diamond coating bite into the surface of the screw head recess. Cam-out is reduced in this way by a considerable amount. This is particularly critical when the surrounding surfaces are sensitive or expensive.

With the microparticle diamond coating, WITTE DIAMOND bits provide unbeatable grip and, thanks to the high-grade gold coating, optimum corrosion protection.



### PH for PHILLIPS recess screws



**BITFLEX**  
with the damping zone  
between the drive and tip



DIN ISO1173

ITEM NO.	+	mm	1/4" drive
27971	PH 1	25	6.3 mm
27972	PH 2	25	6.3 mm
27973	PH 3	25	6.3 mm

ITEM NO.	+	mm	1/4" drive
27391	PH 1	25	C6.3
27392	PH 2	25	C6.3
27393	PH 3	25	C6.3

### PZ for POZIDRIV screws



**BITFLEX**  
with the damping zone  
between the drive and tip



DIN ISO1173

ITEM NO.	+	mm	1/4" drive
28011	PZ 1	25	6.3 mm
28012	PZ 2	25	6.3 mm
28013	PZ 3	25	6.3 mm

ITEM NO.	+	mm	1/4" drive
27611	PZ 1	25	C6.3
27612	PZ 2	25	C6.3
27613	PZ 3	25	C6.3

### PH for PHILLIPS recess screws



1 unit on a blister card

ITEM NO.	+	mm	1/4" drive
26630	PH 1	25	C6.3
26631	PH 2	25	C6.3
26632	PH 3	25	C6.3

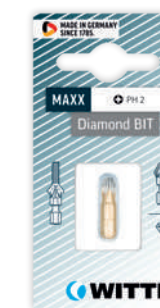

Article may deviate from illustration

### PZ for POZIDRIV screws



1 unit on a blister card

ITEM NO.	+	mm	1/4" drive
26636	PZ 1	25	C6.3
26637	PZ 2	25	C6.3
26638	PZ 3	25	C6.3

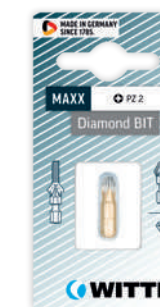

Article may deviate from illustration

## RATCHDRIVE® DIAMOND

Order no. 25106

Qty	ITEM NO.	Drive	mm	1/4" drive
1	26294		60	E6.3
1	<b>27391</b>	PH 1	25	C6.3
1	27392	PH 2	25	C6.3
1	<b>27393</b>	PH 3	25	C6.3
1	27611	PZ 1	25	C6.3
1	<b>27612</b>	PZ 2	25	C6.3
1	27613	PZ 3	25	C6.3



## COMBIT-BOX® DIAMOND, 7-pcs. set

Order no. 28557 Order no. 33300

Qty	ITEM NO.	Drive	mm	1/4" drive
1	26294		60	E6.3
1	<b>27391</b>	PH1	25	C6.3
1	27392	PH2	25	C6.3
1	<b>27393</b>	PH3	25	C6.3
1	27611	PZ1	25	C6.3
1	<b>27612</b>	PZ2	25	C6.3
1	27613	PZ3	25	C6.3



## COMBIT-BOX® DIAMOND, 11-pcs. set

Order no. 28452 Order no. 28462

Qty	ITEM NO.	Drive	mm	1/4" drive
1	26294		60	E6.3
1	<b>27391</b>	PH1	25	C6.3
3	27392	PH2	25	C6.3
1	<b>27393</b>	PH3	25	C6.3
1	27611	PZ1	25	C6.3
3	<b>27612</b>	PZ2	25	C6.3
1	27613	PZ3	25	C6.3

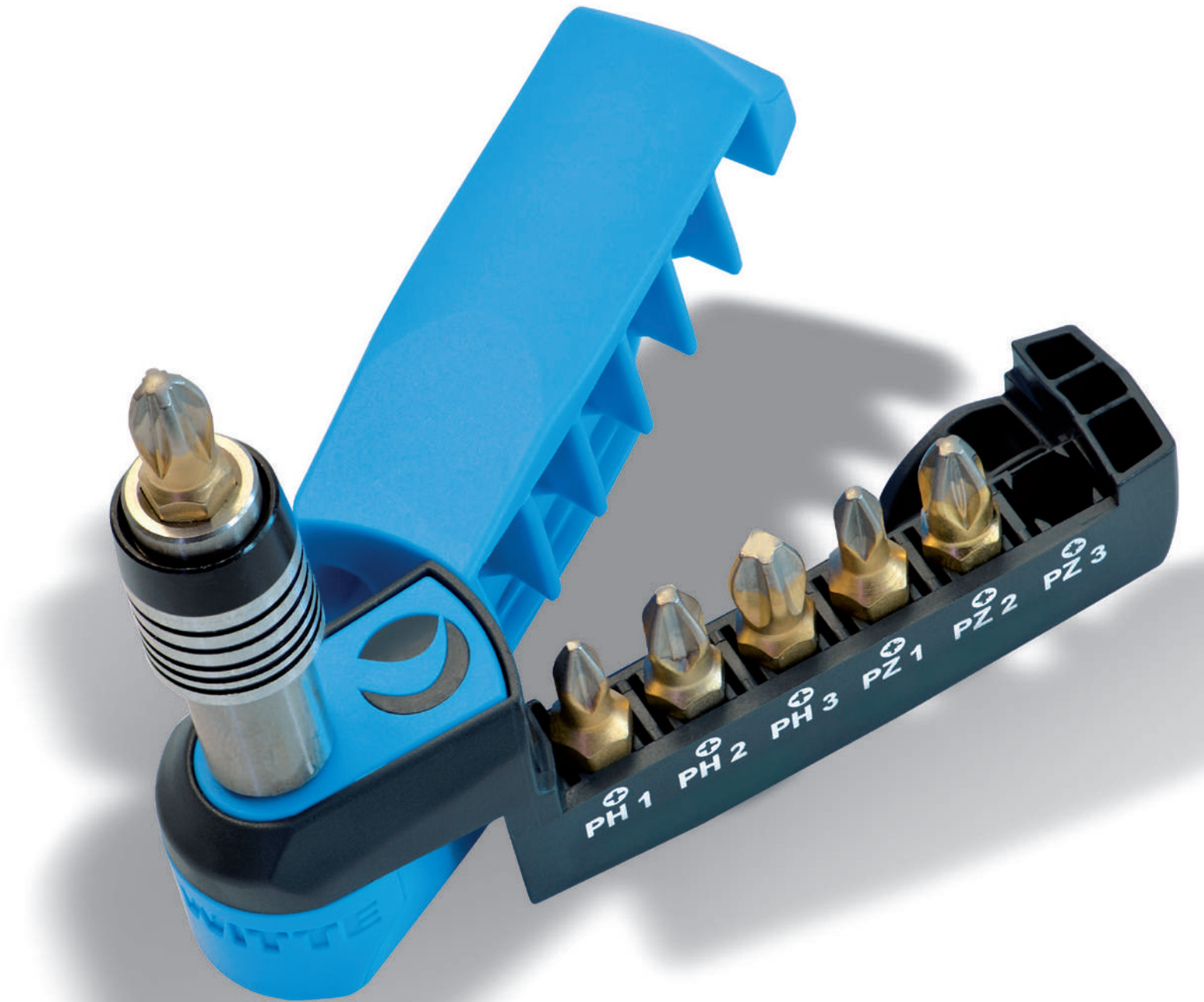



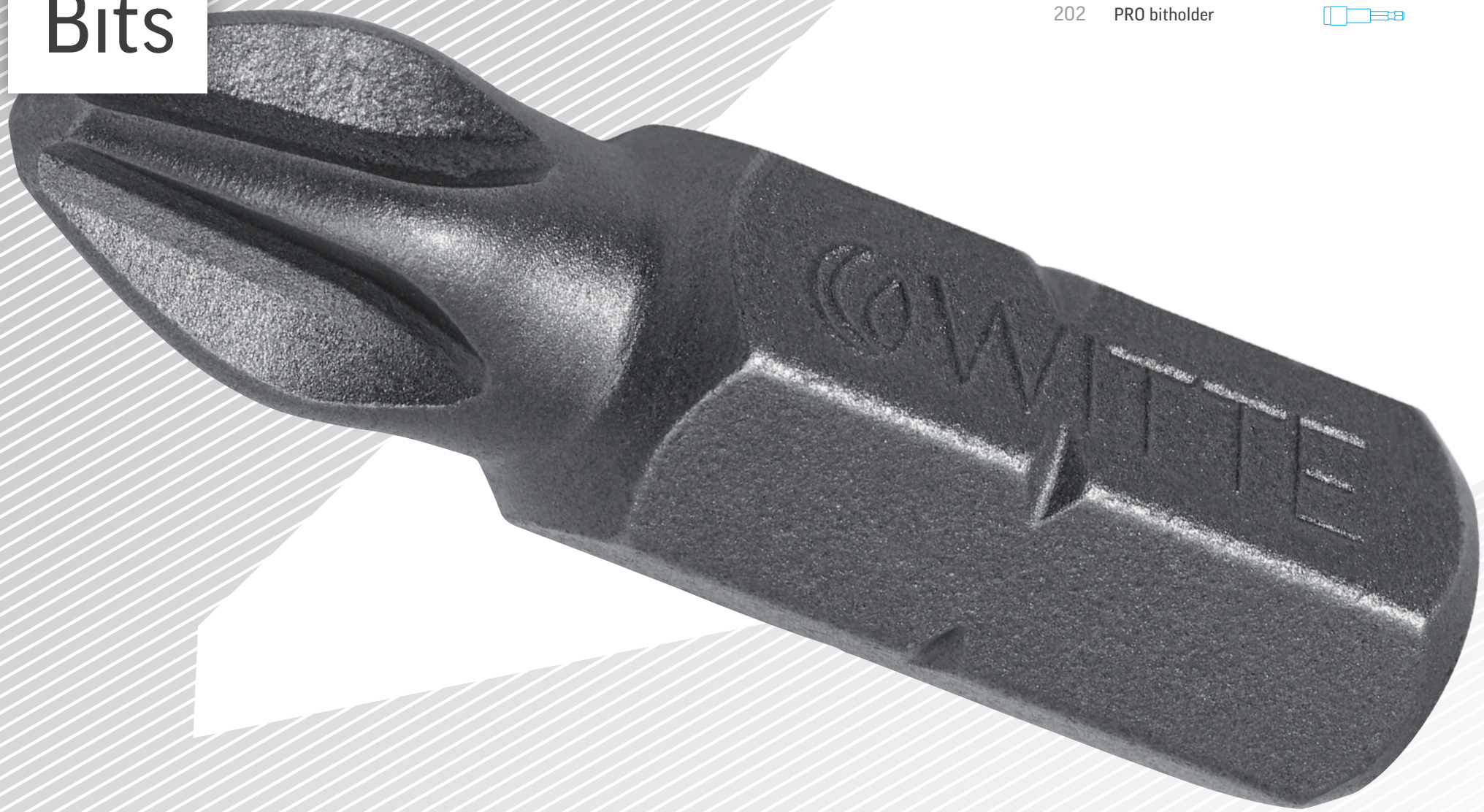

**PRO**

**Bits**



**188 Bits**  
Industrial bits at a glance

- 190 PRO Bits 
- 202 PRO bitholder 



# PRO Bits



Robust quality bits for industrial use

WITTE PRO bits have proved their worth due to their consistently high quality – resulting from state-of-the-art production processes.

The complex hardening process guarantees permanent hardness of 59–61 HRC to meet tough requirements in industry and the trades.

## PZ for POZIDRIV screws



**BITFLEX**  
with the damping zone  
between the drive and tip



DIN ISO1173

ITEM NO.	+	mm	1/4" drive
28045	PZ 1	25	6.3 mm
28046	PZ 2	25	6.3 mm
28047	PZ 3	25	6.3 mm

ITEM NO.	+	mm	1/4" drive
27043	PZ 0	25	C6.3
27045	PZ 1	25	C6.3
27046	PZ 2	25	C6.3
27047	PZ 3	25	C6.3
27052	PZ 2	32	C6.3
27053	PZ 3	32	C6.3
27048	PZ 4	32	C6.3



DIN ISO1173



Truncated tip  
DIN ISO1173

ITEM NO.	+	mm	1/4" drive
27545	PZ 1	50	E6.3
27546	PZ 2	50	E6.3
27547	PZ 3	50	E6.3
27548	PZ 4	50	E6.3

ITEM NO.	+	mm	1/4" drive
27057	PZ 2	25	C6.3



DIN ISO1173



DIN ISO1173

ITEM NO.	+	mm	1/4" drive
27560	PZ 1	70	E6.3
27565	PZ 2	70	E6.3
27570	PZ 3	70	E6.3
27561	PZ 1	90	E6.3
27566	PZ 2	90	E6.3
27571	PZ 3	90	E6.3
27562	PZ 1	110	E6.3
27567	PZ 2	110	E6.3
27572	PZ 3	110	E6.3
27563	PZ 1	125	E6.3
27568	PZ 2	125	E6.3
27573	PZ 3	125	E6.3
27564	PZ 1	150	E6.3
27569	PZ 2	150	E6.3
27574	PZ 3	150	E6.3

ITEM NO.	+	mm	5/16" drive
27811	PZ 1	32	C8
27812	PZ 2	32	C8
27813	PZ 3	32	C8
27814	PZ 4	32	C8



DIN ISO1173



DIN ISO1173

ITEM NO.	+	mm	Drive 5.5 mm
30701	PZ 1	50	A5.5
30702	PZ 2	50	A5.5
30703	PZ 3	50	A5.5

ITEM NO.	+	mm	7.0 mm drive
30801	PZ 1	53	G7
30802	PZ 2	53	G7
30803	PZ 3	53	G7



## PH

for PHILLIPS recess screws



ITEM NO.	+	mm	1/4" drive
28021	PH 1	25	6.3 mm
28022	PH 2	25	6.3 mm
28023	PH 3	25	6.3 mm

DIN ISO1173

ITEM NO.	+	mm	1/4" drive
27520	PH 1	50	E6.3
27521	PH 2	50	E6.3
27522	PH 3	50	E6.3
27523	PH 4	50	E6.3

DIN ISO1173

ITEM NO.	+	mm	1/4" drive
27450	PH 1	70	E6.3
27455	PH 2	70	E6.3
27460	PH 3	70	E6.3
27451	PH 1	90	E6.3
27456	PH 2	90	E6.3
27461	PH 3	90	E6.3
27452	PH 1	110	E6.3
27457	PH 2	110	E6.3
27462	PH 3	110	E6.3
27453	PH 1	125	E6.3
27458	PH 2	125	E6.3
27463	PH 3	125	E6.3
27454	PH 1	150	E6.3
27459	PH 2	150	E6.3
27464	PH 3	150	E6.3

DIN ISO1173

ITEM NO.	+	mm	5.5 mm drive
30691	PH 1	50	A5.5
30692	PH 2	50	A5.5
30693	PH 3	50	A5.5

DIN ISO1173

ITEM NO.	+	mm	1/4" drive
27018	PH 0	25	C6.3
27020	PH 1	25	C6.3
27021	PH 2	25	C6.3
27022	PH 3	25	C6.3
27012	PH 2	32	C6.3
27013	PH 3	32	C6.3
27023	PH 4	32	C6.3

Truncated tip  
DIN ISO1173

ITEM NO.	+	mm	1/4" drive
27036	PH 2	25	C6.3

DIN ISO1173

ITEM NO.	+	mm	5/16" drive
27801	PH 1	32	C8
27802	PH 2	32	C8
27803	PH 3	32	C8
27804	PH 4	32	C8

DIN ISO1173

ITEM NO.	+	mm	7.0 mm drive
30791	PH 1	53	G7
30792	PH 2	53	G7
30793	PH 3	53	G7

## TORX®



ITEM NO.	+	mm	1/4" drive
29459	T 4	25	C6.3
29460	T 5	25	C6.3
29490	T 6	25	C6.3
29495	T 7	25	C6.3
29501	T 8	25	C6.3
29502	T 9	25	C6.3
29503	T 10	25	C6.3
29504	T 15	25	C6.3
29505	T 20	25	C6.3
29506	T 25	25	C6.3
29507	T 27	25	C6.3
29508	T 30	25	C6.3
29509	T 40	25	C6.3



ITEM NO.	+	mm	1/4" drive
29671	T 10	70	E6.3
29672	T 15	70	E6.3
29673	T 20	70	E6.3
29674	T 25	70	E6.3
29675	T 27	70	E6.3
29676	T 30	70	E6.3
29677	T 40	70	E6.3
29681	T 10	90	E6.3
29682	T 15	90	E6.3
29683	T 20	90	E6.3
29684	T 25	90	E6.3
29685	T 27	90	E6.3
29686	T 30	90	E6.3
29687	T 40	90	E6.3
29691	T 10	150	E6.3
29692	T 15	150	E6.3
29693	T 20	150	E6.3
29694	T 25	150	E6.3
29695	T 27	150	E6.3
29696	T 30	150	E6.3
29697	T 40	150	E6.3



ITEM NO.	+	mm	1/4" drive
29603	T 10	50	E6.3
29604	T 15	50	E6.3
29605	T 20	50	E6.3
29606	T 25	50	E6.3
29607	T 27	50	E6.3
29608	T 30	50	E6.3
29609	T 40	50	E6.3



ITEM NO.	+	mm	5/16" drive
27820	T 25	35	C8
27821	T 27	35	C8
27822	T 30	35	C8
27823	T 40	35	C8
27824	T 45	35	C8
27825	T 50	35	C8
27827	T55	35	C8

## TORX® TAMPER RESISTANT



ITEM NO.	+	mm	1/4" drive
29477	TR 7	25	C6.3
29478	TR 8	25	C6.3
29479	TR 9	25	C6.3
29480	TR 10	25	C6.3
29481	TR 15	25	C6.3
29482	TR 20	25	C6.3
29483	TR 25	25	C6.3
29484	TR 27	25	C6.3
29485	TR 30	25	C6.3
29486	TR 40	25	C6.3

## Five-star



ITEM NO.	+	mm	1/4" drive
26870	IPR 10	25	C6.3
26871	IPR 15	25	C6.3
26872	IPR 20	25	C6.3
26873	IPR 25	25	C6.3
26874	IPR 27	25	C6.3
26875	IPR 30	25	C6.3
26876	IPR 40	25	C6.3

## SPANNER BITS



Tamper-proof bits  
for security fasteners

ITEM NO.			mm	1/4" drive
26481	4	0.8 x 3.5	25	C6.3
26482	6	0.8 x 4.3	25	C6.3
26483	8	1.0 x 5.3	25	C6.3
26484	10	1.2 x 6.2	25	C6.3

## Slotted



DIN ISO1173



DIN ISO1173

ITEM NO.			mm	1/4" drive	ITEM NO.			mm	1/4" drive
26410	0.5 x 4.0	25	C6.3	27510	0.5 x 4.0	50	E6.3		
26411	0.6 x 4.5	25	C6.3	27511	0.6 x 4.5	50	E6.3		
26412	0.8 x 5.5	25	C6.3	27512	0.8 x 5.5	50	E6.3		
26413	1.0 x 6.0	25	C6.3	27513	1.0 x 6.0	50	E6.3		
26414	1.2 x 6.5	25	C6.3	27514	1.2 x 6.5	50	E6.3		
26415	1.6 x 8.0	25	C6.3	27515	1.6 x 8.0	50	E6.3		
26416	1.6 x 9.0	38	C6.3	27516	1.6 x 9.0	50	E6.3		



DIN ISO1173



DIN ISO1173

ITEM NO.			mm	5/16" drive	ITEM NO.			mm	5.5 mm drive
27828	0.8 x 5.5	41	C8	30680	0.5 x 4.0	50	A5.5		
27831	1.0 x 6.0	41	C8	30681	0.6 x 4.5	50	A5.5		
27829	1.2 x 6.5	41	C8	30682	0.8 x 5.5	50	A5.5		
27832	1.6 x 8.0	41	C8	30683	1.0 x 6.0	50	A5.5		
27833	1.6 x 10.0	41	C8	30684	1.2 x 6.5	50	A5.5		
27834	2.0 x 12.0	41	C8	30685	1.6 x 8.0	50	A5.5		



DIN ISO1173

ITEM NO.			mm	7.0 mm drive
30780	0.5 x 4.0	53	G7	
30781	0.6 x 4.5	53	G7	
30782	0.8 x 5.5	53	G7	
30783	1.0 x 6.0	53	G7	
30784	1.2 x 6.5	53	G7	
30785	1.6 x 8.0	53	G7	

## XZN triple-square



DIN ISO1173



DIN ISO1173

ITEM NO.			mm	1/4" drive	ITEM NO.			mm	5/16" drive
27414	M 4	25	C6.3	27840	M 4	35	C8		
27415	M 5	25	C6.3	27841	M 5	35	C8		
27416	M 6	25	C6.3	27842	M 6	35	C8		
27418	M 8	25	C6.3	27843	M 8	35	C8		
				27844	M 10	35	C8		
				27845	M 12	35	C8		

## Square drive



DIN ISO1173



DIN ISO1173

ITEM NO.			mm	1/4" drive	ITEM NO.			mm	1/4" drive
27091	1	25	C6.3	27591	1	50	E6.3		
27092	2	25	C6.3	27592	2	50	E6.3		
27093	3	25	C6.3	27593	3	50	E6.3		

## MODUL PHILLIPS

for +/- screws in electrical installations



DIN ISO1173



DIN ISO1173

ITEM NO.			mm	1/4" drive	ITEM NO.			mm	1/4" drive
26461	PH 1 / MODUL	70	E6.3	26471	PZ 1 / MODUL	70	E6.3		
26462	PH 2 / MODUL	70	E6.3	26472	PZ 2 / MODUL	70	E6.3		

## TORQ-SET



DIN ISO1173



DIN ISO1173

ITEM NO.			mm	1/4" drive	ITEM NO.			mm	5/16" drive
27330	TS 0	25	C6.3	27394	TS 8	32	C8		
27331	TS 1	25	C6.3	27395	TS 10	32	C8		
27332	TS 2	25	C6.3	27396	TS 1/4"	32	C8		
27333	TS 3	25	C6.3	27397	TS 5/16"	32	C8		
27334	TS 4	25	C6.3	27398	TS 3/8"	32	C8		
27335	TS 5	25	C6.3						
27336	TS 6	25	C6.3						
27337	TS 8	25	C6.3						
27338	TS 10	25	C6.3						
27339	TS 1/4"	32	C6.3						



## Internal hex



DIN ISO1173

ITEM NO.	Ø	l mm	1/4" drive
27080	1.5	25	C6.3
27081	2	25	C6.3
27082	2.5	25	C6.3
27083	3	25	C6.3
27084	4	25	C6.3
27085	5	25	C6.3
27086	6	25	C6.3
27087	8	25	C6.3



DIN ISO1173

ITEM NO.	Ø	l mm	5/16" drive
27851	4	30	C8
27852	5	30	C8
27853	6	30	C8
27854	7	30	C8
27855	8	30	C8
27856	10	30	C8



DIN ISO1173

ITEM NO.	Ø	l mm	1/4" drive
27193	3	50	E6.3
27194	4	50	E6.3
27195	5	50	E6.3
27196	6	50	E6.3
27198	8	50	E6.3



DIN ISO1173

ITEM NO.	Ø	l mm	5.5 mm drive
30753	3	50	A5.5
30754	4	50	A5.5
30755	5	50	A5.5
30756	6	50	A5.5
30758	8	50	A5.5

## Ball-end



DIN ISO1173

ITEM NO.	Ø	l mm	1/4" drive
27183	3	50	E6.3
27184	4	50	E6.3
27185	5	50	E6.3
27186	6	50	E6.3

## External hex



Magnetic  
DIN ISO1173

ITEM NO.	Ø	l mm	1/4" drive
26231	5	45	E6.3
26232	5.5	45	E6.3
26233	6	45	E6.3
26234	7	45	E6.3
26235	8	45	E6.3
26236	9	45	E6.3
26237	10	45	E6.3
26238	11	45	E6.3
26239	12	45	E6.3
26240	13	45	E6.3
26241	1/4"	45	E6.3
26242	3/8"	45	E6.3
26243	5/16"	45	E6.3

## TRI-WING



DIN ISO1173

ITEM NO.	Ø	l mm	1/4" drive
27480	TW 0	25	C6.3
27481	TW 1	25	C6.3
27482	TW 2	25	C6.3
27483	TW 3	25	C6.3
27484	TW 4	25	C6.3
27485	TW 5	25	C6.3

## 1/4" Adapters



DIN ISO1173

ITEM NO.	Ø	l mm	1/4" drive
26298	1/4"	25	C6.3
26398	1/4"	50	C6.3

## Double-ended bits



ITEM NO.	+	+	l mm	1/4" drive
29010	PH 1	PZ 1	60	6.3 mm
29011	PH 2	PZ 2	60	6.3 mm
29012	PH 3	PZ 3	60	6.3 mm



ITEM NO.	+	+	l mm	1/4" drive
29001	PH 1	0.6 x 4.5	60	6.3 mm
29002	PH 2	0.8 x 5.5	60	6.3 mm
29003	PH 3	1.0 x 6.0	60	6.3 mm



ITEM NO.	+	+	l mm	1/4" drive
29004	PZ 1	0.6 x 4.5	60	6.3 mm
29005	PZ 2	0.8 x 5.5	60	6.3 mm
29006	PZ 3	1.0 x 6.0	60	6.3 mm



ITEM NO.	+	+	l mm	1/4" drive
29007	0.5 x 3.0	0.6 x 4.5	60	6.3 mm
29008	0.8 x 5.5	1.0 x 6.0	60	6.3 mm
29009	1.2 x 6.5	1.6 x 8.0	60	6.3 mm



ITEM NO.	+	+	l mm	1/4" drive
29016	T 10	T 15	60	6.3 mm
29017	T 20	T 25	60	6.3 mm
29018	T 30	T 40	60	6.3 mm

## PH

for PHILLIPS recess screws



2 unit on a blister card

ITEM NO.	+	mm	1/4" drive
26720	PH 1	25	C6.3
26721	PH 2	25	C6.3
26722	PH 3	25	C6.3



Article may deviate from illustration

## PZ

for POZIDRIV screws



2 unit on a blister card

ITEM NO.	+	mm	1/4" drive
26716	PZ 1	25	C6.3
26717	PZ 2	25	C6.3
26718	PZ 3	25	C6.3



Article may deviate from illustration

## TORX®



2 unit on a blister card

ITEM NO.	+	mm	1/4" drive
26810	T 10	25	C6.3
26811	T 15	25	C6.3
26812	T 20	25	C6.3
26813	T 25	25	C6.3
26817	T 27	25	C6.3
26814	T 30	25	C6.3
26815	T 40	25	C6.3



Article may deviate from illustration

## PH BITLFEX

for PHILLIPS recess screws



2 unit on a blister card

ITEM NO.	+	mm	1/4" drive
26771	PH 1	25	6.3 mm
26772	PH 2	25	6.3 mm
26773	PH 3	25	6.3 mm



Article may deviate from illustration

## PZ BITFLEX

for POZIDRIV screws



2 unit on a blister card

ITEM NO.	+	mm	1/4" drive
26801	PZ 1	25	6.3 mm
26802	PZ 2	25	6.3 mm
26803	PZ 3	25	6.3 mm



Article may deviate from illustration



## PH

for PHILLIPS recess screws



in plastic case

ITEM NO.	+	Qty	mm	1/4" drive
427020	PH 1	25	25	C6,3
427021	PH 2	25	25	C6,3
427022	PH 3	15	25	C6,3



Article may deviate from illustration

## PZ

for POZIDRIV screws



in plastic case

ITEM NO.	+	Qty	mm	1/4" drive
427045	PZ 1	25	25	C6,3
427046	PZ 2	25	25	C6,3
427047	PZ 3	15	25	C6,3

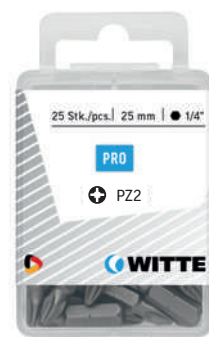

Article may deviate from illustration

## TORX®



in plastic case

ITEM NO.	+	Qty	mm	1/4" drive
429503	T 10	5	25	C6,3
429504	T 15	5	25	C6,3
429505	T 20	5	25	C6,3
429506	T 25	5	25	C6,3
429507	T 27	5	25	C6,3
429508	T 30	5	25	C6,3
429509	T 40	5	25	C6,3



Article may deviate from illustration

## PH BITLFLEX

for PHILLIPS recess screws



in plastic case

ITEM NO.	+	Qty	mm	1/4" drive
428022	PH 2	25	25	C6,3



Article may deviate from illustration

## PZ BITFLEX

for POZIDRIV screws



in plastic case

ITEM NO.	+	Qty	mm	1/4" drive
428046	PZ 2	25	25	6,3 mm
428047	PZ 3	15	25	6,3 mm



Article may deviate from illustration

## PH - 50 mm

for PHILLIPS recess screws



in plastic case

ITEM NO.	+	Qty	mm	1/4" drive
427520	PH 1	10	50	E6,3
427521	PH 2	10	50	E6,3
427522	PH 3	10	50	E6,3



Article may deviate from illustration

## PZ - 50 mm

for POZIDRIV screws



in plastic case

ITEM NO.	+	Qty	mm	1/4" drive
427545	PZ 1	10	50	E6,3
427546	PZ 2	10	50	E6,3
427547	PZ 3	10	50	E6,3



Article may deviate from illustration

## TORX® - 50 mm



in plastic case

ITEM NO.	+	Qty	mm	1/4" drive
429603	T 10	5	50	E6,3
429604	T 15	5	50	E6,3
429605	T 20	5	50	E6,3
429606	T 25	5	50	E6,3
429607	T 27	5	50	E6,3
429608	T 30	5	50	E6,3
429609	T 40	5	50	E6,3



Article may deviate from illustration

## Bitholders

With permanent magnet



ITEM NO.	Drive	mm
26006	1/4" ● E6.3 DIN 3126 Universal without snap ring	60



ITEM NO.	Drive	mm
26294	1/4" ● E6.3 DIN 3126 Universal with quick-action chuck and snap ring	60



ITEM NO.	Drive	mm
26002	5.5 mm ● A5.5 DIN 3126 with snap ring	79



ITEM NO.	Drive	mm
26005	11.0 mm with snap ring	82



ITEM NO.	Drive	mm
26001	1/4" ● E6.3 DIN 3126 Universal with snap ring	75
26014	Universal with snap ring	150
26024	Universal with snap ring	200



ITEM NO.	Drive	mm
28310	1/4" ● E6.3 DIN 3126 Depth stop with magnetic retain- er function, without snap ring	60



ITEM NO.	Drive	mm
26003	7.0 mm ● G7 DIN 3126 with snap ring	77



ITEM NO.	Drive	mm
26009	10.0 mm SDS plus with snap ring	78

## Magnetic holders

1 unit on a blister card

ITEM NO.	mm	1/4" drive
26704	60	E6.3 DIN 3126
28319	60	E6.3 DIN 3126
26703	60	E6.3 DIN 3126
26010	75	E6.3 DIN 3126



Article may deviate from illustration

## 429702 Magnetic screw holders

in a plastic case

mm	mm	Colour
4.5	21	Green
6.0	21	Orange
8.0	21	Blue



Article may deviate from illustration

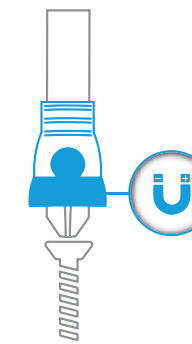

## RATCHDRIVE® INDUSTRY

Order no. 25101

Qty	ITEM NO.	Drive	mm	1/4" drive
1			60	E6.3
1	27020	PH 1	25	C6.3
1	27021	PH 2	25	C6.3
1	27022	PH 3	25	C6.3
1	27045	PZ 1	25	C6.3
1	27046	PZ 2	25	C6.3
1	27047	PZ 3	25	C6.3



Application see p. 183

## RATCHDRIVE® INDUSTRY

Order no. 25102

Qty	ITEM NO.	Drive	mm	1/4" drive
1			60	E6.3
1	29503	T 10	25	C6.3
1	29504	T 15	25	C6.3
1	29505	T 20	25	C6.3
1	29506	T 25	25	C6.3
1	29508	T 30	25	C6.3
1	29509	T 40	25	C6.3



Application see p. 183



### COMBIT-BOX® INDUSTRY, 7-pcs. set

Order no. 28551 Order no. 33400

Qty	ITEM NO.	Drive	mm	1/4" drive
1	26294		60	E6.3
1	27020	PH 1	25	C6.3
1	27021	PH 2	25	C6.3
1	27022	PH 3	25	C6.3
1	27045	PZ 1	25	C6.3
1	27046	PZ 2	25	C6.3
1	27047	PZ 3	25	C6.3



### COMBIT-BOX® INDUSTRY, 11-pcs. set

Order no. 28456 Order no. 28466

Qty	ITEM NO.	Drive	mm	1/4" drive
1	26294		60	E6.3
1	29503	T 10	25	C6.3
2	29504	T 15	25	C6.3
2	29505	T 20	25	C6.3
2	29506	T 25	25	C6.3
2	29508	T 30	25	C6.3
1	29509	T 40	25	C6.3



### COMBIT-BOX® INDUSTRY, 7-pcs. set

Order no. 28552 Order no. 33401

Qty	ITEM NO.	Drive	mm	1/4" drive
1	26294		60	E6.3
1	29503	T 10	25	C6.3
1	29504	T 15	25	C6.3
1	29505	T 20	25	C6.3
1	29506	T 25	25	C6.3
1	29508	T 30	25	C6.3
1	29509	T 40	25	C6.3



### COMBIT-BOX® INDUSTRY, 11-pcs. set

Order no. 28457 Order no. 28467

Qty	ITEM NO.	Drive	mm	1/4" drive
1	26294		60	E6.3
1	29503	T 10	25	C6.3
1	29504	T 15	25	C6.3
1	29505	T 20	25	C6.3
1	29506	T 25	25	C6.3
1	29508	T 30	25	C6.3
1	29509	T 40	25	C6.3
1	27020	PH 1	25	C6.3
2	27021	PH 2	25	C6.3
1	27022	PH 3	25	C6.3



### COMBIT-BOX® INDUSTRY, 11-pcs. set

Order no. 28458  Order no. 28468

Qty	ITEM NO.	Drive	mm	1/4" drive
1	<b>26294</b>		60	E6.3
1	29503	T 10	25	C6.3
1	29504	T 15	25	C6.3
1	29505	T 20	25	C6.3
1	29506	T 25	25	C6.3
1	29508	T 30	25	C6.3
1	29509	T 40	25	C6.3
1	27045	PZ 1	25	C6.3
2	27046	PZ 2	25	C6.3
1	27047	PZ 3	25	C6.3



### COMBIT-BOX® INDUSTRY, 11-pcs. set

Order no. 28454  Order no. 28464

Qty	ITEM NO.	Drive	mm	1/4" drive
1	<b>26294</b>		60	E6.3
1	27020	PH 1	25	C6.3
2	27021	PH 2	25	C6.3
2	27022	PH 3	25	C6.3
2	27045	PZ 1	25	C6.3
2	27046	PZ 2	25	C6.3
1	27047	PZ 3	25	C6.3



### COMBIT-BOX® INDUSTRY, 11-pcs. set

Order no. 28455  Order no. 28465

Qty	ITEM NO.	Drive	mm	1/4" drive
1	<b>26294</b>		60	E6.3
1	27020	PH 1	25	C6.3
2	27021	PH 2	25	C6.3
1	27022	PH 3	25	C6.3
1	27045	PZ 1	25	C6.3
2	27046	PZ 2	25	C6.3
1	27047	PZ 3	25	C6.3
1	26412	0.8 x 5.5	25	C6.3
1	26414	1.2 x 6.5	25	C6.3



### 31200 BITBOX 24-pcs. set

Bit and ratchet set

Qty	ITEM NO.	Drive	mm	1/4" drive
1			51	E6.3
1				
1	<b>27020</b>	PH 1	25	C6.3
3	27021	PH 2	25	C6.3
1	27022	PH 3	25	C6.3
1	27045	PZ 1	25	C6.3
3	27046	PZ 2	25	C6.3
1	27047	PZ 3	25	C6.3
1	29503	T 10	25	C6.3
1	29504	T 15	25	C6.3
1	29505	T 20	25	C6.3
1	29506	T 25	25	C6.3
1	29508	T 30	25	C6.3
1	29509	T 40	25	C6.3
1	26412	0.8 x 5.5	25	C6.3
1	26414	1.2 x 6.5	25	C6.3
1		8.0	25	C6.3
1		10.0	25	C6.3
1		13.0	25	C6.3
1			25	C6.3



### 312012 BITBOX 32-pcs. set

incl. 30 bits and a holder

Qty	ITEM NO.	Drive	mm	1/4" drive
1	<b>26006</b>		60	E6.3
1	27020	PH 1	25	C6.3
7	27021	PH 2	25	C6.3
1	27022	PH 3	25	C6.3
1	27045	PZ 1	25	C6.3
7	27046	PZ 2	25	C6.3
1	27047	PZ 3	25	C6.3
1	29503	T 10	25	C6.3
2	29504	T 15	25	C6.3
3	29505	T 20	25	C6.3
3	29506	T 25	25	C6.3
2	29508	T 30	25	C6.3
1	29509	T 40	25	C6.3
1	26298		25	C6.3

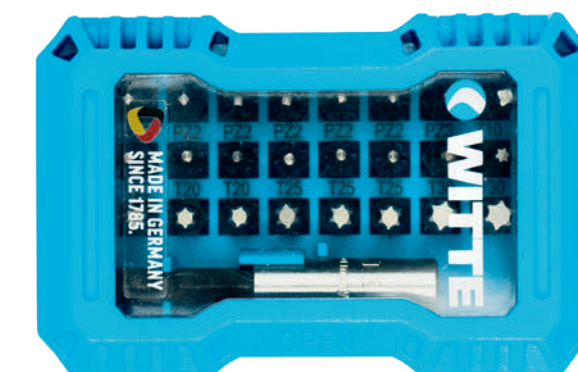



## BITCOMMANDER



- Includes three high-quality sockets
- Robust, durable plastic housing
- Includes 1/4" reversible ratchet and convenient magnetic holder
- Up to 30 WITTE bits in one convenient set
- Compact storage - all present and correct



**At a moment's notice**  
Bitcommander has a convenient clip - ideal for mobile work.



**Magnetic insert**  
as convenient holder for bits and fasteners

### 28035 BITCOMMANDER, 35-pcs. set

Qty	Drive	mm	1/4" drive
1		60	E6.3
1		95	
1		25	C6.3
2		25	C6.3
2		25	C6.3
2		25	C6.3
2		25	C6.3
2		25	C6.3
2		25	C6.3
2		25	C6.3
2		25	C6.3
2		25	C6.3
2		25	C6.3
2		25	C6.3
2		25	C6.3
1		25	C6.3
1		25	C6.3
1		25	C6.3
1		25	C6.3
1		25	C6.3
1		25	C6.3
1		25	C6.3
1		25	C6.3

### 28020 BITCOMMANDER, 20-pcs. set

Qty	Drive	mm	1/4" drive
1		60	E6.3
1		95	
1		25	C6.3
1		25	C6.3
2		25	C6.3
1		25	C6.3
1		25	C6.3
2		25	C6.3
1		25	C6.3
1		25	C6.3
1		25	C6.3
1		25	C6.3
1		25	C6.3
1		25	C6.3
1		25	C6.3
1		25	C6.3
1		25	C6.3
1		25	C6.3



#### The advantages

- High-quality and safe: robust plastic housing for longer service lifetimes
- Compact and tidy
- Comprehensive: all popular tool sizes included
- Mobile solution for easy transport - carry it with you

**PRO**

Gift boxes





### 97024 Bottle-opener

in high-quality packaging



ITEM NO.  mm

97024 115 x 34



### 97023 Corkscrew

in high-quality packaging



ITEM NO.  mm

97023 95



### 97022 Duo gift box

Bottle-opener and corkscrew in high-quality packaging



ITEM NO.  mm  mm  mm  mm

97023 43 115 x 34 59 95





**SOFT CASE**

**Sets**

 **MADE IN GERMANY  
SINCE 1785.**

 **WITTE**  
WERKZEUGE



# SETS

## Easy removal

Open belt pocket provides good retention but easy accessibility



## Always within reach

Thanks to the practical belt loop

## Quick-access set

individual tool compilation in one compact set

## Very hard-wearing

Thanks to high-grade materials and reinforced seams

## Light and compact

Easy to stow, even where space is at a premium

## Ergonomically designed, tidy arrangement

Optimum, fast removal of the tool needed



## More than just a helpful aid

Durable, robust materials and heavy-duty zip

## Versatile

Premium tools for a wide variety of applications

## SET characteristics



Room for pliers and screwdrivers



Robust textile coupled with reinforced seams guarantee the wallet stands up to hard wear

The ideal companion for anyone who prefers not to carry a hard case or metal tool case around: WITTE sets in textile bags are light and easy to transport, but still provide ample protection for your tools. The combination of materials and the way they are processed guarantee impressive durability.

## The advantages

- Safe: ample protection for your tools
- Mobile: low weight, less space required
- Resilient: thanks to robust materials and good craftsmanship in first-rate WITTE quality

- Flexible: available in a number of tool combinations for different fields of application
- High-quality WITTE tools, made in Germany



## WITTE MINISET 1, 5-pcs. set

Order no. 301142

Material: polyester 1680D  
Internal dimensions: 240 mm x 270 mm  
Weight: 1000 g



SB 1.0 x 5.5 x 125	115 x 34
SB 1.2 x 6.5 x 125	115 x 34
PH 2 x 100	115 x 34



Side-cutters MH 3.0 / H 2.3 / P 1.6	160 mm
Radio and telephone engineer's pliers MH 2.8 / H 1.8	200 mm



## WITTE MEDISET 1, 11-pcs. set

Order no. 301212

Material: polyester 1680D  
Internal dimensions: 280 mm x 310 mm  
Weight: 2272 g



T 15 x 80	105 x 25
T 20 x 100	105 x 25
T 25 x 100	105 x 25
T 30 x 115	115 x 34
T 40 x 125	125 x 37



Side-cutters MH 3.0 / H 2.3 / P 1.6	160 mm
Radio and telephone engineer's pliers MH 2.8 / H 1.8	200 mm
Slip-joint pliers R 1/8"-1 1/4" / S 6-38 mm	250 mm



Ratchdrive  
PH 2, PH 3, PZ 2, PZ 3, SB 4.5, SB 5.5



Set of ball-end offset screwdrivers  
1.5-2.0-2.5-3.0-4.0-5.0-6.0-8.0-10.0



Carpenter's wooden rule  
Joints with metal fittings



## WITTE MINISET 3 VDE, 3-pcs. set

Order no. 301172

Material: polyester 1680D  
Dimensions: 135 mm x 240 mm  
Weight: 468 g

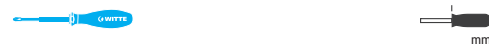

EL 0.8 x 4.0 x 100	105 x 25
PH 2 x 100	115 x 34



VDE multifunction side-cutters MH 3.5 / H 2.5 / P 2.0	180 mm
--	--------



## WITTE MINISET 4 VDE, 4-pcs. set

Order no. 301182

Material: polyester 1680D  
Dimensions: 135 mm x 240 mm  
Weight: 577 g



Voltage tester SB 3.0 x 65	88 x 21
EL 0.8 x 4.0 x 100	105 x 25
PH 2 x 100	115 x 34



VDE side-cutters MH 3.0 / H 2.3 / P 1.6	160 mm
--	--------





## WITTE MINISET 1 VDE, 5-pcs. set

Order no. 301152

Material: polyester 1680D  
Internal dimensions: 240 mm x 270 mm  
Weight: 1049 g



EL 1.0 x 4.0 x 100	105 x 25
EL 0.8 x 5.5 x 125	115 x 34
PH 2 x 100	115 x 34



VDE side-cutters MH 3.0 / H 2.3 / P 1.6	160 mm
Radio and telephone engineer's VDE pliers MH 2.8 / H 1.8	200 mm

## WITTE MINISET 2 VDE Slim, 5-pcs. set

Order no. 301162

Material: polyester 1680D  
Internal dimensions: 240 mm x 270 mm  
Weight: 1040 g



EL 1.0 x 5.5 x 125 (slim)	115 x 34
Voltage tester SB 3.0 x 65	88 x 21
PH 2 x 100 (slim)	115 x 34



VDE side-cutters MH 3.0 / H 2.3 / P 1.6	160 mm
Radio and telephone engineer's VDE pliers MH 2.8 / H 1.8	200 mm

## WITTE MEDISET 1 VDE, 11-pcs. set

Order no. 301202

Material: polyester 1680D  
Internal dimensions: 280 mm x 310 mm  
Weight: 1912 g



EL 1.0 x 2.5 x 75	105 x 25
EL 0.8 x 4.0 x 100	105 x 25
EL 0.4 x 5.5 x 125	115 x 34
Voltage tester SB 3.0 x 65	88 x 21
PH 2 x 100	115 x 34
PZ 2 x 100	115 x 34



VDE side-cutters MH 3.0 / H 2.3 / P 1.6	160 mm
Radio and telephone engineer's VDE pliers MH 2.8 / H 1.8	200 mm
VDE wire stripper Ø 5 mm / 10 mm <sup>2</sup>	160 mm



Set of key wrenches  
1.5-2.0-2.5-3.0-4.0-5.0-6.0-8.0-10.0



Carpenter's wooden rule  
Joints with metal fittings 2000 mm

## WITTE MAXISET 1 VDE, 20-pcs. set

Order no. 301262

Material: polyester 1680D  
Internal dimensions: 270 mm x 400 mm  
Weight: 2625 g



EL 1.0 x 2.5 x 75	105 x 25
EL 0.8 x 4.0 x 100	105 x 25
EL 0.4 x 5.5 x 125	115 x 34
Voltage tester SB 3.0 x 65	88 x 21
PH 1 x 80	105 x 25
PH 2 x 100	115 x 34
PZ 1 x 80	105 x 25
PZ 2 x 100	115 x 34
T 10 x 100	105 x 25
T 15 x 100	105 x 25
T 20 x 75	105 x 25
T 25 x 60	105 x 25



VDE multifunction pliers MH 3.5 / H 2.5 / P 2.0	180 mm
Radio and telephone engineer's VDE pliers MH 2.8 / H 1.8	200 mm
VDE combination pliers MH 2.8 / H 2.5 / P 1.6	180 mm



Set of key wrenches  
1.5-2.0-2.5-3.0-4.0-5.0-6.0-8.0-10.0



Switch-cabinet key



Propelling pencil with sharpener  
Lead thickness 5.6 mm, clip and plunger made of metal



Carpenter's wooden rule  
Joints with metal fittings 2000 mm



Spirit level with 2 tubes 250 mm



POS

Displays and accessories





### POS system, unassembled, RAL 9006

Order no. 46910, width 100 x height 220 cm, white aluminium, without light box

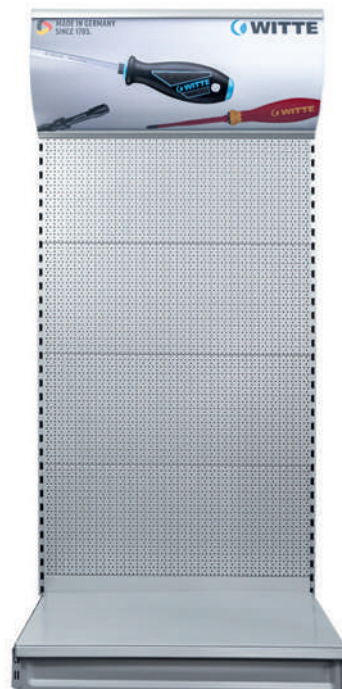

### POS light box

Order no. 30301, width 98 x height 37 x depth 24.5 cm, for inserting in the POS system, with insert sheet



### POS magnetic film

Order no. 46912, width 100 x height 40 cm, brand panel for the POS system



### POS system, unassembled, RAL 9005

Order no. 46911, width 100 x height 220 cm, black, without light box



### POS revolving sales stand, assembled, 3-sided

Order no. 46913, height 185 x depth 40 cm

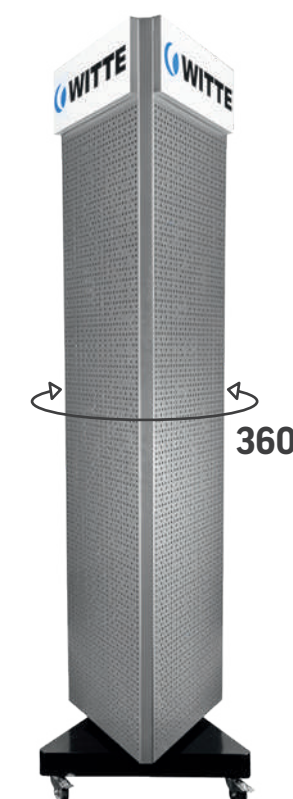

**POS hooks for perforated panels, zinc-plated (silver)**

Order no. 85810, length 14 cm, packed in 10s



**POS hooks for perforated panels, powder-coated (black)**

Order no. 85820, length 14 cm, packed in 10s



**POS double hooks for perforated panels, zinc-plated (silver)**

Order no. 85830, length 10 cm, packed in 10s



**POS double hooks for perforated panels, powder-coated (black)**

Order no. 85840, length 10 cm, packed in 10s



**POS perforated wall stand with 11 hooks for screwdrivers**

Order no. 85800, width 50 x depth 36 cm, incl. brand panel, without screwdrivers, black, other colours on request



Suggested configuration

**POS perforated wall stand with 5 hooks for T-handles**

Order no. 23820, width 50 x height 23 x depth 17 cm, incl. brand panel, without screwdrivers, black, other colours on request



Suggested configuration

**POS – Perforated wall stand for 125 screwdrivers**

Order no. 22491, width 100 x depth 26 cm, incl. brand panel, without screwdrivers



Suggested configuration

**Header panel with supplementary 9-hook display**

Order no. 26756, width 50 x depth 18 cm, without self-service boxes, black, other colours on request



Suggested configuration

**Supplementary 9-hook display**

Order no. 26757, width 50 x depth 18 cm, black, other colours on request



Suggested configuration

**Header panel with supplementary 9-hook display**

Order no. 26756, width 50 x depth 18 cm, without blister cards, black, other colours on request

**Supplementary 9-hook display**

Order no. 26757, width 50 x depth 18 cm, black, other colours on request



**POS display for screwdrivers, 40 units,**

Order no. 230008, sales display for sets, width 35 x height 63 x depth 35 cm, incl. brand panel, without screwdrivers



Suggested configuration

**POS display for screwdrivers, 55 units,**

Order no. 230009, width 48 x height 44 x depth 26.5 cm, incl. brand panel, without screwdrivers



Suggested configuration

**POS display for screwdriver sets, 24 units,**

Order no. 230006, width 37 x height 90 x depth 37 cm, incl. brand panel, without screwdriver sets



Suggested configuration

**POS counter display for bit boxes and self-service boxes, without content**

Order no. 141172, width 27 x height 42 x depth 31 cm, without self-service boxes



Suggested configuration

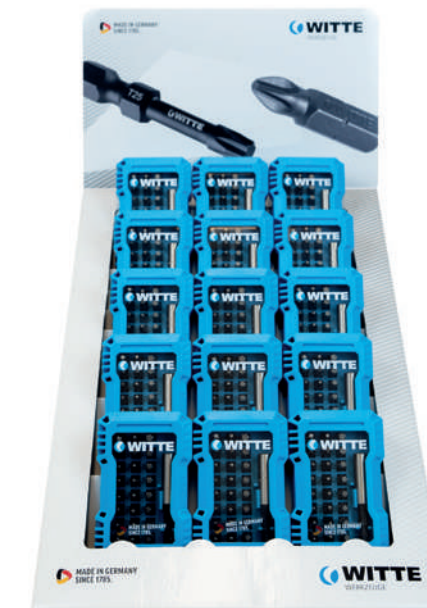

Suggested configuration







## Key word index

From A to Z

■ MAXX

■ PRO

<b>A</b>	
Adapters	202, 203
Allen keys	see p. 239
Allen keys	132
Allen keys, sets of	134
Allen keys, sets of	137 et seq.
Awls	20, 63
<b>B</b>	
Ball-end bits	see p. 239
Ball-end key wrenches	see p. 239
Ball-end screwdrivers	see p. 239
Ball-end sets of key wrenches	see p. 239
Bit boxes	167, 179, 180, 200, 201
Bitholders	see p. 239
Bitholders for drills	see p. 239
BITCOMMANDER	208
BITDRIVE®	84
BITDRIVE® RATCHET	88
BITDRIVE® TORQUE	92
BITDRIVE® TORQUE VDE	96
Bits	164, 188
Bits, Diamond	184
Bits, Extra hard	174
Bits, impact	164
Bits, industry	188
Bits, PRO Bitflex	191, 192
Bits, stainless	170
Bits, TiN	176
Blister card	166, 172, 178, 179, 185, 198, 199, 203
Bottle opener	20, 50, 63
<b>C</b>	
Carburettor screwdrivers	19, 20, 62
COMBIT box, diamond	186
COMBIT box, impact	168
COMBIT box, industry	204, 205, 206
COMBIT box, stainless	173
COMBIT box, TiN	181
Cork screwdriver	48
Cork screwdriver sets	51
Corkscrew	212
Cruciform bits	see p. 239
Cruciform screwdrivers	see p. 239
<b>D</b>	
Diamond bits	184
Double-ended bits	197
DRY WALL bit, IMPACT	165
<b>E</b>	
Electrician's screwdrivers	16, 26, 60, 70
Electronics screwdrivers	30, 36, 76, 80 96
Electronics sets of screwdrivers	34, 39, 79, 83
ESD screwdrivers	100
ESD WITTRON®	126
Extra hard bits	174
<b>F</b>	
Five-star bits	see p. 239
Four-sided awls	20, 63

<b>G</b>	
Gift boxes	212
<b>H</b>	
Hex screwdrivers	see p. 239
Holders	202, 203
<b>I</b>	
Impact bit DRY WALL	165
Impact bits	164
Impact cap screwdrivers	72, 108
Impact screwdriver	72
Impact sets of screwdrivers	74
Industry bits	188
Insulated screwdrivers	30, 36, 76, 80
Internal hex drive bits	see p. 239
Internal hex drive key wrenches	see p. 239
Internal hex drive screwdrivers	see p. 239
Internal square drive bits	see p. 239
Internal square drive screwdrivers	see p. 239
<b>M</b>	
Magnetic holders	202, 203
Magnetic screw holders	203
Male hex bits	see p. 239
Male hex screwdrivers	see p. 239
MAXX bottle-opener	14
MAXX ESD screwdrivers	100
MAXX heavy-duty combination pliers	144
MAXX heavy-duty side-cutters	143
MAXX heavy-duty telephone engineer's pliers	142
MAXX Plus screwdrivers	24
MAXX Plus sets of screwdrivers	29
MAXX screwdrivers	20
MAXX sets of screwdrivers	23
MAXX VDE cable shears	150
MAXX VDE heavy-duty combination pliers	149
MAXX VDE heavy-duty side-cutters	148
MAXX VDE heavy-duty telephone eng. pliers	146
MAXX VDE multifunction side-cutters	147
MAXX VDE screwdrivers	30
MAXX VDE sets of screwdrivers	34
MAXX VDE Slim screwdrivers	36
MAXX VDE Slim sets of screwdrivers	36
MAXX voltage testers	40
MAXX Women Line	52
MAXXPRO Nature screwdrivers	48
MAXXPRO Nature sets of screwdrivers	51
MAXXPRO stainless screwdrivers	44
MAXXPRO stainless sets of screwdrivers	47
MODUL bits	see p. 239
MODUL screwdrivers	see p. 239
<b>N</b>	
Nutdrivers	see p. 239
Nutdrivers	see p. 239
Nutdrivers, flexible	see p. 239
<b>P</b>	
PH bits	see p. 239
PH Phillips screwdrivers	see p. 239
PH Phillips screwdrivers with hex bolster	17, 27, 74
Picks & hooks	20

<b>P</b>	
Pliers & cutters	
Combination plier	156
Heavy-duty combination plier	144
Heavy-duty side-cutter	143
Heavy-duty telephone engineer's plier	142
Side-cutter	155
Telephone engineer's plier	154
VDE cable shear	150
VDE combination plier	159
VDE heavy-duty combination plier	149
VDE heavy-duty side-cutter	143
VDE heavy-duty telephone eng. plier	142
VDE multifunction side-cutter	147
VDE radio and telephone engineer's plier	158
VDE side-cutter	161
VDE wire-stripper	160
Water pump plier	157
POS displays and accessories	222
Counter display	229
Displays	228
displays and accessories	224
Header panel with supplementary display	227
Hooks for perforated panels	226
Light box	225
Magnetic film	225
Perforated wall displays	226
Revolving sales stand	225
Supplementary displays	227
Systems	224
PRO bit box	207
PRO BITDRIVE®	63
PRO BITDRIVE® RATCHET	84
PRO BITDRIVE® TORQUE	88
PRO BITDRIVE® TORQUE VDE	92
PRO bits	188
PRO bottle-opener	96
PRO combination pliers	156
PRO impact screwdrivers	72
PRO impact sets of screwdrivers	74
PRO Nature screwdrivers	108
PRO Nature sets of screwdrivers	111
PRO Plus screwdrivers	68
PRO Plus sets of screwdrivers	71
PRO radio & telephone engineer's pliers	154
PRO screwdrivers	58
PRO sets of screwdrivers	65
PRO side-cutters	155
PRO slip-joint pliers	157
PRO T-handles	112
PRO VDE combination pliers	159
PRO VDE radio & telephone engineer's pliers	158
PRO VDE screwdrivers	76
PRO VDE sets of screwdrivers	79
PRO VDE side-cutters	161
PRO VDE Slim screwdrivers	80
PRO VDE Slim sets of screwdrivers	83
PRO VDE wire-strippers	160
PRO voltage testers	104
PRO Wittron ESD screwdrivers	126
PRO Wittron ESD sets of screwdrivers	129
PRO Wittron screwdrivers	116
PRO Wittron sets of screwdrivers	120, 121
PRO Wittron VDE screwdrivers	122
PRO Wittron VDE sets of screwdrivers	124, 125

<b>P</b>	
PZ bits	see p. 239
PZ Pozidriv screwdrivers	see p. 239
PZ Pozidriv screwdrivers with hex bolster	17, 27, 74
<b>R</b>	
Ratchdrive Diamond	186
Ratchdrive Industry	203
Ratchdrive Stainless	173
Ratchdrive TiN	181
<b>S</b>	
Slotted bits	see p. 239
Slotted screwdrivers	see p. 239
Soft case sets	214
Square bits	see p. 239
Square screwdrivers	see p. 239
Stainless bits	see p. 239
Stainless steel bits	170
Stainless steel screwdrivers	44
Stainless steel sets of screwdrivers	47
Stubby (carburettor) screwdrivers	19, 20, 62
<b>T</b>	
T-bars	112
TiN bits	176
Torq-Set bits	see p. 239
TORX® bits	see p. 239
TORX® key wrenches	see p. 239
TORX® key wrenches, sets of	138, 139
TORX® screwdrivers	see p. 239
TORX® sets of screwdrivers	23, 29, 47, 65, 71, 120, 121, 124, 125, 138, 139
TORX® TR bits	see p. 239
TORX® TR screwdrivers	see p. 239
TORX® TR screwdrivers, sets of	23, 29, 65
TRI-WING bits	see p. 239
TRI-WING screwdrivers	see p. 239
<b>U</b>	
Universal holders	202, 203
<b>V</b>	
VDE screwdrivers	30, 36, 76, 80 96
VDE sets of screwdrivers	34, 39, 79, 83
VDE WITTRON®	126
Voltage testers	40, 104
<b>W</b>	
Women Line	52
Wooden-handled screwdrivers	108
Wooden-handled sets of screwdrivers	111
Workshop screwdrivers	16, 26, 50, 60, 70, 74, 102, 110
Workshop screwdrivers with hex bolster	16, 26, 74
<b>X</b>	
XZN triple-square bits	see p. 239
XZN triple-square key wrenches	see p. 239



## Fastener assignment of WITTE screwdrivers to screw types

### Slotted screws

a x b (DIN 5264)	Countersunk screws			Raised countersunk screws			Cheesehead screws	Panhead screws				Mushroom head screws	Grub screws	
	Metric ISO 2009	Steel sheet ISO 1482	Wood DIN 97	Metric ISO 2010	Steel sheet ISO 1483	Wood DIN 95	Metric ISO 1207	Metric ISO 1580	Metric DIN 920	Metric DIN 921	Steel sheet ISO 1481	Wood DIN 96	DIN EN 24766 27435	DIN 427
0.4 x 2			1.6			1.6						1.6	3	2.5
0.4 x 2.5	1.6		2	1.6			1.6	1.6	2.5	1.6			3.5	3
0.5 x 3	2	2.2		2	2.2	2	2	2	3		2.2	2		3.5
0.5 x 4)									3.5	2			4	
0.6 x 3.5	2.5		2.5	2.5		2.5	2.5					2.5		4
0.6 x 4.5)								2.5	4	2.5			5	
0.8 x 4	3	2.9	3/3.5	3	2.9	3/3.5	3	3			2.9	3	6	5
0.8 x 5.5*									5	3/3.5		3.5		
1 x 5.5	3.5	3.5	4/4.5	3.5	3.5	4/4.5	3.5	3.5	6	4	3.5	4/4.5	8	6
1.2 x 6.5	4/5	4.2/4.8	5/5.5	4/5	4.2/4.8	5	4	4			4.2			8
1.2 x 8						5.5	5		8	5	4.8	5/5.5		
1.6 x 8	6	5.5/6.3	6/7	6	5.5/6.3	6/7	6	6	10			6	10/12	10
1.6 x 10			10			8		6	10	6	5.5/6.3	7		12
2 x 12	8	8	1	8	8		8	8		8	8	8		14
2.5 x 14	10	9.5		10	9.5		10	10		10	9.5			16/18/20

### PHILLIPS recess

ISO 8764	Metric			Self-tapping screws		Woodscrews		
	ISO 2009	ISO 1482	DIN 97	ISO 2010	ISO 1483	DIN 95	ISO 1207	ISO 1207
Size 0	1.6	1.6	1.6	2.2	2.2		2	
	2	2	1.8					
Size 1	2.5	2.5	2	2.9	2.9	2.5	2.5	2.5
	3	3	2.5			3	3	3
			3					
Size 2	3.5	3.5	3.5	3.5	3.5	3.5	3.5	3.5
	4	4	4	4.2	4.2	4	4	4
	5	5	5	4.8	4.8	4.5	4.5	4.5
					5	5	5	
Size 3	6	6	6	5.5	5.5	5.5	5.5	5.5
				6.3	6.3	6	6	6
					7	7	7	
Size 4	8	8	8	8	8	8	8	8
	10	10	10	9.5	9.5			

### SUPADRIV / POZIDRIV

ISO 8764	Metric			Self-tapping screws		Woodscrews		
	ISO 2009	ISO 1482	DIN 97	ISO 2010	ISO 1483	DIN 95	ISO 1207	ISO 1207
Size 0	1.6	1.6	1.6	2.2	2.2		2	
	2	2	1.8					
Size 1	2.5	2.5	2	2.9	2.9	2.5	2.5	2.5
	3	3	2.5			3	3	3
Size 2	3.5	3.5	3.5	3.5	3.5	3.5	3.5	3.5
	4	4	4	4.2	4.2	4	4	4
	5	5	5	4.8	4.8	4.5	4.5	4.5
					5	5	5	
Size 3	6	6	6	5.5	5.5	5.5	5.5	5.5
				6.3	6.3	6	6	6
					7	7	7	
Size 4	8	8	8	8	8	8	8	8
	10	10	10	9.5	9.5			

### Internal hex

Size	Metric screws				Grub screws		
	DIN 908	*DIN 912	DIN 7984	ISO 7991	*DIN 913 / 916	*DIN 914	*DIN 915
1.5		1.6					
		2			3	3	3
2		2.5	3	3	4	4	4
	2.5	3	4	4	5	5	5
3		4	5	5	6	6	6
	4	5	6	6	8	8	8
5	10	6	8	8	10	10	10
	12	8		10	12	12	12
6	14				14	14	14
	16/18	10	12	12	16	16	16
8	20/22	12	14	14	18	18	18
				16	20	20	20
12	24	14	16	18	22	22	22
	26		18	20	24	24	24

### External hex

Size	Metric screws		Self-tap- ping screws	Wood screws
	DIN 931	DIN 933	DIN 7976	DIN 571
3.5				
4	2	2		
4.5				
5	2.5	2.5		2.9
5.5	3	3		3.5
6	3.5	3.5		
7	4	4	4	3.9
				4.2
8	5	5	5	4.8
				5.5
9				
10	6	6	6	6.3
11	7	7		
12			7	
13	8	8	8	8
14				

### Internal TORX®

TORX sizes	DIN 912	DIN 965	Metric screws				Self-tapping screws			
			DIN 966	DIN 7984 6912	DIN 7984	DIN 7991	DIN 7981	DIN 7982	DIN 7983	
T5	1.42	1.4/1.6	1.8		1.4/1.6	1.4/1.6	*	*	*	*
T6	1.70	1.3/2	2	*	1.3/2	1.3/2	*	*	*	*
T7	1.99	*	*	*	*	*	*	*	*	*
T8	2.31	2.5	2.5	2.5	2.5	2.5	2.5	2.9	2.9	2.9
T9	2.50							2.9		
T10	2.74	3	3	3	3	3	3	3.5	3.5	3.5
T15	3.27	3.5	3.5	3.5	3.5	3.5		3.9	3.9	3.9
T20	3.86		4	4		4	4	4.2	4.2	4.2
T25	4.43	4	5	5	4	5	5	4.8/5.5	4.8/5.5	4.8/5.5
T27	4.99	4.3/5	**	**	4.3/5	**	**	**	**	**
T30	5.52	6	6	6	6	6	6	6.3	6.3	6.3
T40	6.65	8	8	8	8	8	8	8		
T45	7.82	**	**	**	**	**	**	**	**	**
T50	8.83	10	10	10	10	10	10	10		
T55	11.22	12			12			12		
T60	13.25	14			14					

\* Special screws M 1.6 – 2.0 for reversible tungsten carbide tips

\*\* Special screws



## PROFIL FINDER

- MAXX
- MAXX Plus
- MAXX VDE
- MAXX VDE Slim
- MAXX voltage tester
- MAXXPRO Stainless
- MAXXPRO Nature
- MAXXPRO Women Line
- PRO
- PRO Plus
- PRO Impact
- PRO VDE
- PRO VDE Slim
- BITDRIVE®
- BITDRIVE® RATCHET
- BITDRIVE® TORQUE
- BITDRIVE® TORQUE VDE
- PRO ESD
- PRO voltage testers
- PRO Nature
- PRO T-bars
- PRO WITTRON®
- PRO WITTRON® VDE
- PRO WITTRON®ESD
- PRO Allen keys
- MAXX Impact
- MAXX Stainless
- MAXX Extra hard
- MAXX TiN
- MAXX Diamond
- PRO bits

Slotted	PH	PZ	MODUL PH	MODUL PZ	TORX®	TORX® TR	External hex	Sockets	Bitholders	Internal hex drive	Ball-end	Square drive	Awls	Adapters	TRI-WING	TORQ-SET	XZN triple-square	Five star	Spanner, snake-eye
---------	----	----	----------	----------	-------	----------	--------------	---------	------------	--------------------	----------	--------------	------	----------	----------	----------	-------------------	-----------	--------------------

	16	16	17			17	18	19	19		18	18	20		18				18	
	26	26	27			27	28	28			28	28							28	
	32	32	32	32	32	33		33				33								
	38	38	38	38	38							38								
	43																			
	46	46	46			46														
	50	50	50																	
	54	54	54																	
	60	60	60			61	61	61	62			61	63							
	70	70	70			71														
	74	74	74																	
	78	78	78	78	78	79		79												
	82	82	82	82	82															
		87	87			87														
		91	91			91														
	99	99																		
	102	102																		
	106																			
	110	110	110																	
						114		115	115	114										
	118	118	118			118		119	119	119	119									
	124	124				124														
	128	128				128		128												
						134		134											135	
						165	165			165										
						171	171			171										
						175	175													
	177	177	177			178	178													
						185	185													
	194	192	191	195	195	193	193	196			196	196	195		197	196	195	195	193	194





As at 03/2020

Our general terms & conditions are deemed to apply.  
These can be found on our website: [www.wittetools.com](http://www.wittetools.com)

KIRCHHOFF Witte GmbH  
Feldmühlenstr. 51 · 58093 Hagen · Germany  
[www.wittetools.com](http://www.wittetools.com) · [info@wittetools.com](mailto:info@wittetools.com)

 **MADE IN GERMANY  
SINCE 1785.**

 **WITTE**